

RADIO RETAINING

28 CENTS PER COPY

McGraw-Hill Publishing Co.

RADIO MAKES
TOMORROW'S MAESTROS



JANUARY, 1938



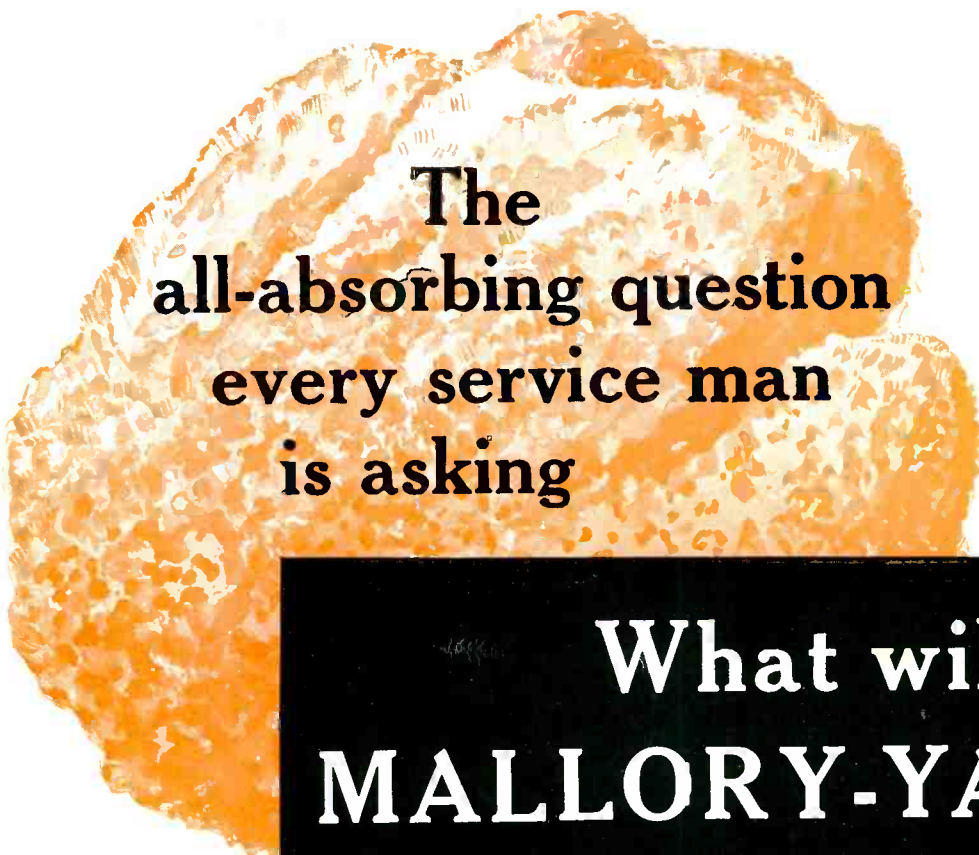

In this issue
1937 Sales Figures



The
all-absorbing question
every service man
is asking

What will MALLORY-YAXLEY do next?

For years Mallory-Yaxley has answered the question with innovations that amazed the industry. And every time Mallory-Yaxley answers the question, it means a step forward in better servicing, better products and better profits.

Mallory-Yaxley has met the service man's question in the past with answers such as  the Mallory-Yaxley Radio Service Encyclopedia  Condensers that are universal in application  Volume Controls that are really silent  with "a mere handful" of Vibrators that service over 3,000,000 automobile radio sets  with perfect portable power, in the Mallory Vibrapack.

Now the question for 1938 is about to be answered! . . .

What will Mallory-Yaxley do next?

You will know mighty soon!

P. R. MALLORY & CO., Inc. • INDIANAPOLIS, INDIANA • Cable Address — PELMALLO

Use
P. R. MALLORY & CO. Inc.
MALLORY
REPLACEMENT
CONDENSERS...VIBRATORS

Use
YAXLEY
REPLACEMENT
VOLUME CONTROLS

RADIO RETAILING

JANUARY, 1938

O. FRED. ROST Editor
W. MacDONALD .. Managing Editor
C. A. NUEBLING .. Technical Editor
T. H. PURINTON .. Assistant Editor
HARRY PHILLIPS Art Director

•
Tom Blackburn Chicago
George Tenney San Francisco
H. S. Knowlton Boston

•
HOWARD EHRLICH
 Executive Vice-President

H. W. MATEER
 Manager

McGraw-Hill Publishing Company, Inc.

Publication Office
 99-129 North Broadway, Albany, N. Y.
 Editorial and Executive Offices
 330 West 42nd Street, New York, N. Y.

Cable Address: MCGRAWHILL, New York
 Member A.B.P. Member A.B.C.

James H. McGraw, Jr. President
 Howard Ehrlich Executive Vice-President
 James H. McGraw Honorary Chairman
 B. R. Putnam Treasurer
 D. C. McGraw Secretary
 A. W. Morrison Circulation Manager

RADIO RETAILING. January, 1938, Vol. 23, No. 1. Published monthly, price 25c copy. Subscription rates—United States and possessions, Canada, Mexico and Central American countries \$1. All other countries \$2 a year or eight shillings. Printed in U. S. A. Entered as Second Class Matter, September 8, 1936, at Post Office, Albany, N. Y., under the Act of March 3, 1879. Cable address "McGrawhill, New York." Member of A.B.P. Member of A.B.C. Copyright 1938 by McGraw-Hill Publishing Co., Inc., 330 West 42d Street, New York, N. Y.

Branch Offices: 520 North Michigan Ave., Chicago; 883 Mission St., San Francisco; Aldwych House, Aldwych, London, WC. 2; Washington; Philadelphia; Cleveland; Detroit; St. Louis; Boston; Atlanta, Ga.

1937 SALES FIGURES	25-32
RADIO MONTH	9
PHOTOSHORTS	11
THE WAY TO SELL WOMEN	14
..... By Mary Davis Gillies	
FIVE LETTERS ABOUT DISCOUNTS	16
DO WE NEED A NATIONAL ASSOCIATION?	18
..... By O. Fred. Rost	
TELEVISION AND THE RADIO INDUSTRY	20
..... By David Sarnoff	
AND, WHAT ABOUT FACSIMILE?	22
..... By Beverly Dudley	
DO YOUR MEN FLOP ON REFRIGERATION?	34
..... By Laurence Wray	
BEST RECORD PROSPECTS	37
..... By Richard Gilbert	
PREVIEW OF NEW MERCHANDISE	40
JANUARY NEWS	53
TECHNICAL TOPICS	67
CIRCUITS	68
SERVICING INTERMITTENT SETS	71
..... By C. L. Smith	
SHOP SHORTCUTS	72
TRICKS OF THE TRADE	76
AUDIO FREQUENCY	84

SALES STATIC . . .

"I think the trouble is this tube. It doesn't light as bright."





Stromberg-Carlson

PRESENTS THE "WINNING HAND" FOR JANUARY!

If you are a Stromberg-Carlson dealer, you have a definite advantage as the new year starts—

You'll have eight new models while other lines are struggling to get rid of a mass of old stuff. You'll have *perfected*, 1938 push button tuning—Electric Flash Tuning. Other lines have last year's.

You'll have the Labyrinth, best sales feature in

radio today—no other line can have the Labyrinth.

You'll have distinctive furniture, planned for the modern home—other lines still have only regulation cabinets of the "cut and dried" type.

You'll have protection from the factory. Some other lines are being cut to where all profit is gone.

You can "cash in" with Stromberg-Carlson.

STROMBERG-CARLSON TELEPHONE MFG. CO., ROCHESTER, N. Y.

No. 235-H Horizontal Model.
Triple Range. Electric Flash
Tuning. Walnut Finish.



ELECTRIC *Flash* TUNING

Touch a button and the station you want comes in, perfectly tuned, without a second's delay. The pre-selected stations are clearly indicated. Station is kept exactly in tune by perfected Automatic Frequency Control. On eight new Stromberg-Carlson models.

JUST TOUCH A
BUTTON...THERE'S
YOUR STATION...

Instantly

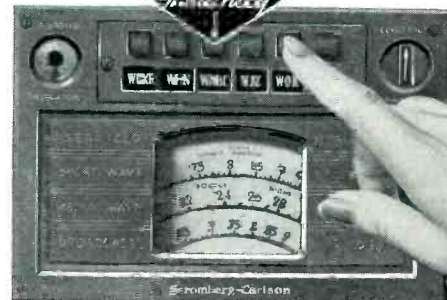

THERE IS NOTHING FINER THAN A STROMBERG-CARLSON

WHEREVER TUBES PLAY A VITAL PART
**... YOU'LL FIND
 RAYTHEON ON THE JOB!**

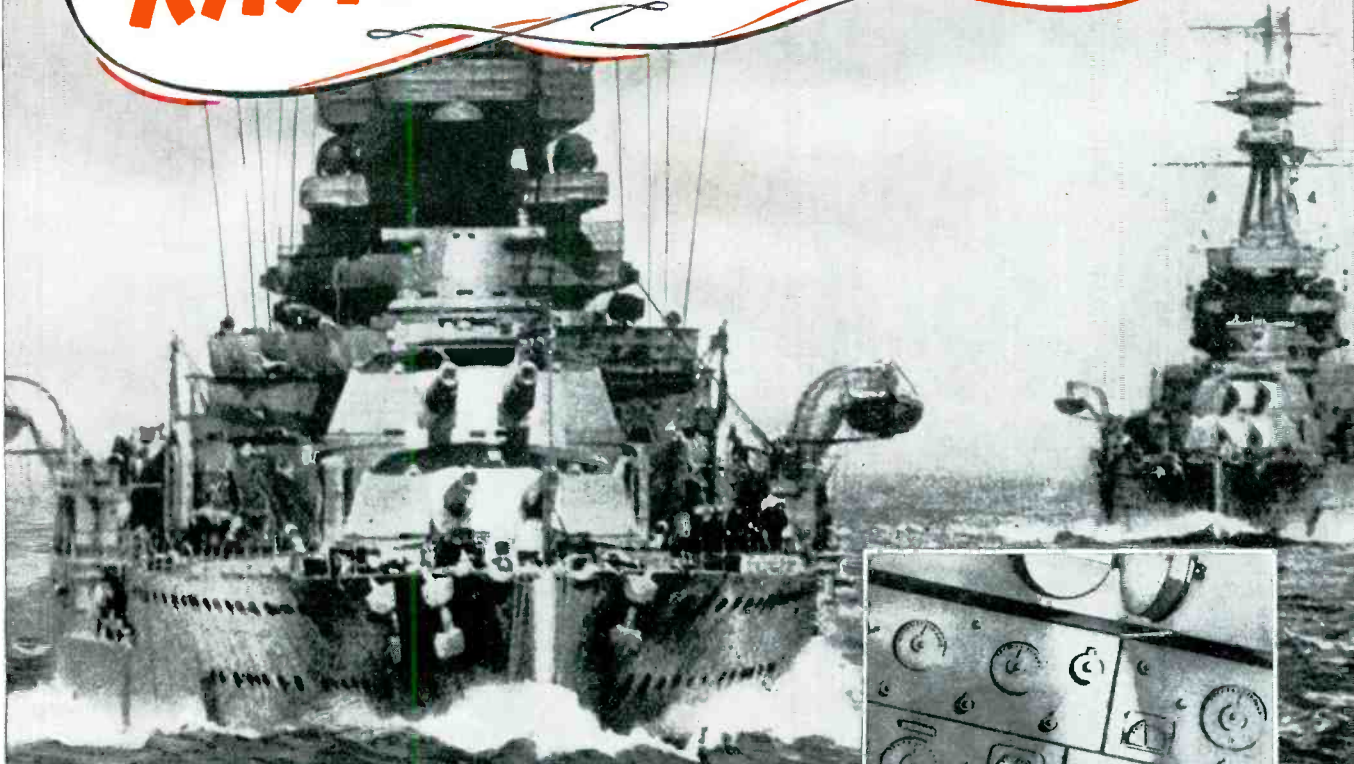

It is just as important for *you* to use top quality tubes as it is for the United States Navy. *They* use Raytheon because it is the tube that can be depended on to work smoothly in any circuit . . . and stand up under the roughest usage and thundering vibration of a battleship under fire. The Navy can't stop in the middle of a battle to find which tube has blown!

Leading licensed set manufacturers, too, prefer Raytheon because of their sturdiness and uniformity. And when *you* make a replacement in a receiver you must be just as confident. That is why thousands of Servicemen and Dealers depend on Raytheon.

Order Raytheon for greater permanent tube profits



RAYTHEON

CHICAGO

NEW YORK

SAN FRANCISCO

ATLANTA

NEWTON MASS.

WORLD'S LARGEST EXCLUSIVE RADIO TUBE MANUFACTURERS

California

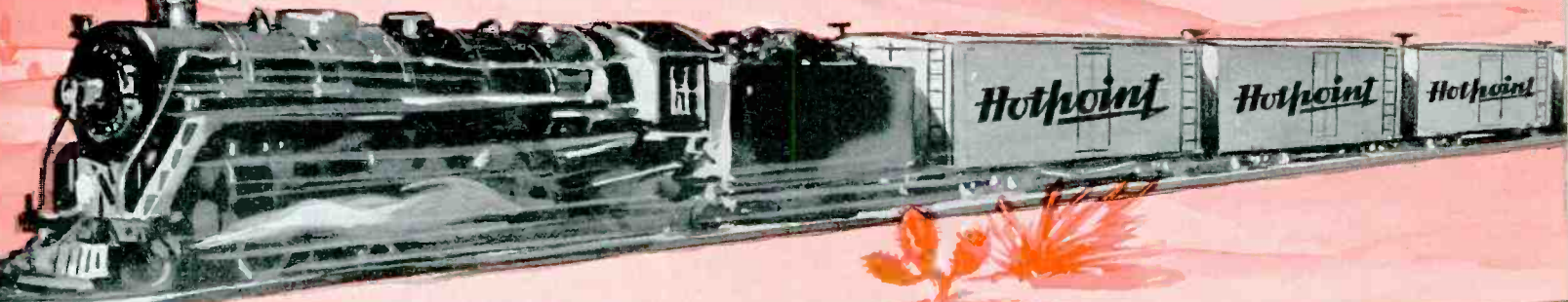

45 SOLID CARLOADS OF *Hotpoint* REFRIGERATORS

FOR SOUTHERN CALIFORNIA TERRITORY



A FULL TRAINLOAD of Hotpoint Refrigerators being loaded for shipment to dealers in Southern California! More trainloads will follow, because these 1938 Hotpoint Refrigerators are taking the market by storm!

They've got *everything*—and they're backed by an aggressive and intelligently directed sales and advertising campaign.

California is going Hotpoint! And Hotpoint is going to California — 45 solid carloads of 1938 Hotpoint Refrigerators! That's the largest single shipment of refrigerators of any make ever to go into this territory. And we're proud — proud to have built a refrigerator that could create such a tremendous demand so quickly!

HERE ARE THE REASONS

Southern California dealers realized—the instant they saw the 1938 Hotpoint line—that these are refrigerators they can sell, because they're the sort people want to buy! The amazing new Circulaire Cooling, that gives 20% faster freezing at even lower cost—the vacuum sealed Thriftmaster mechanism—the Hotpoint Speed Freezer—the new Pop-Ice Trays—the 5 Zones of Cold—the Adjustable Interiors—all these features combine to make Hotpoint's 1938 Refrigerators the greatest ever built! And people are appreciating this fact—with record-breaking purchases!

You still can cash in on the profit opportunity which Hotpoint offers wide-awake dealers from coast to coast. Clip the coupon, fill it out, *mail it today* for full information.

EDISON GENERAL ELECTRIC APPLIANCE CO., Inc.
5680 West Taylor Street, Chicago, Illinois

ELECTRIC RANGES • WATER HEATERS • SINKS AND DISHWASHERS • WASHERS AND IRONERS

See the full line of Hotpoint Appliances at the January Furniture Market, American Furniture Mart, January 3-15, and the House Furnishing Show, Stevens Hotel, Chicago, January 10-18.

Hotpoint

here we come!

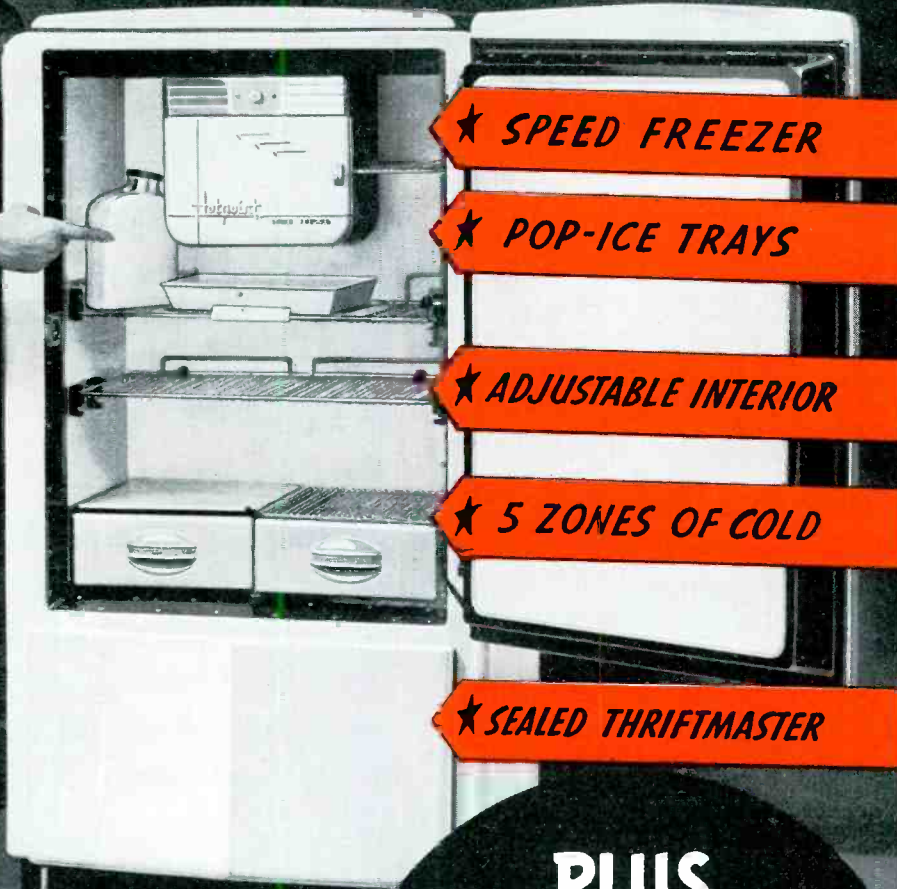

★ **SPEED FREEZER**

★ **POP-ICE TRAYS**

★ **ADJUSTABLE INTERIOR**

★ **5 ZONES OF COLD**

★ **SEALED THRIFTMASTER**

**PLUS
CIRCULAIRE
COOLING**

**20% FASTER FREEZING
AT EVEN LOWER
COST**

THRIFTMASTER. Vacuum-sealed, super-powered, and oil cooled.

SPEED FREEZER. Makes ice cubes and frozen desserts faster than ever.

POP-ICE TRAYS. Release ice cubes — 2 or a trayful — instantly. Ice in a trice.

5 ZONES OF COLD . . .

ADJUSTABLE INTERIOR that affords "custom made"

food storage space — **plus CIRCULAIRE COOLING.** The year's greatest advance in electric refrigeration. Incorporates a radically different principle which pulls heat away from the Thriftmaster. Gives 20% faster freezing at even lower cost.

Go places with Hotpoint in 1938! Get started today.



**ELECTRIC
REFRIGERATORS**

Edison General Electric Appliance Co., Inc.
5680 W. Taylor St., Chicago, Ill.

Please send us literature on the new Hotpoint Refrigerators for 1938.

Name _____
Address _____
City _____ State _____

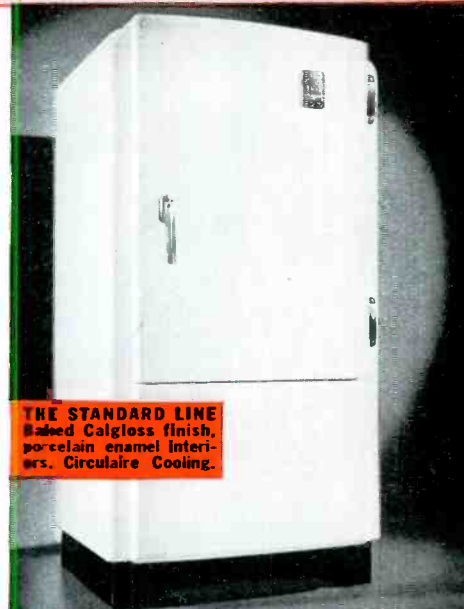

THE STANDARD LINE • Haked Calgloss finish, porcelain enamel interiors. Circulaire Cooling.



THE HOTPOINT IMPERIAL LINE • 6 popular models. Porcelain enamel inside and out. Matched set dishes.

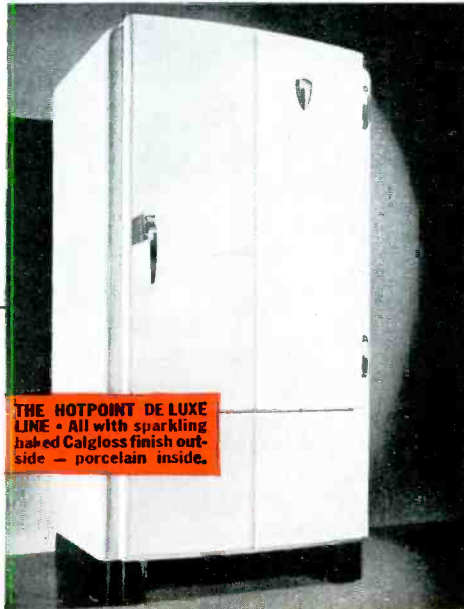

THE HOTPOINT DE LUXE LINE • All with sparkling haked Calgloss finish outside — porcelain inside.

*It's my business
to make more
PROFITS for
YOU*

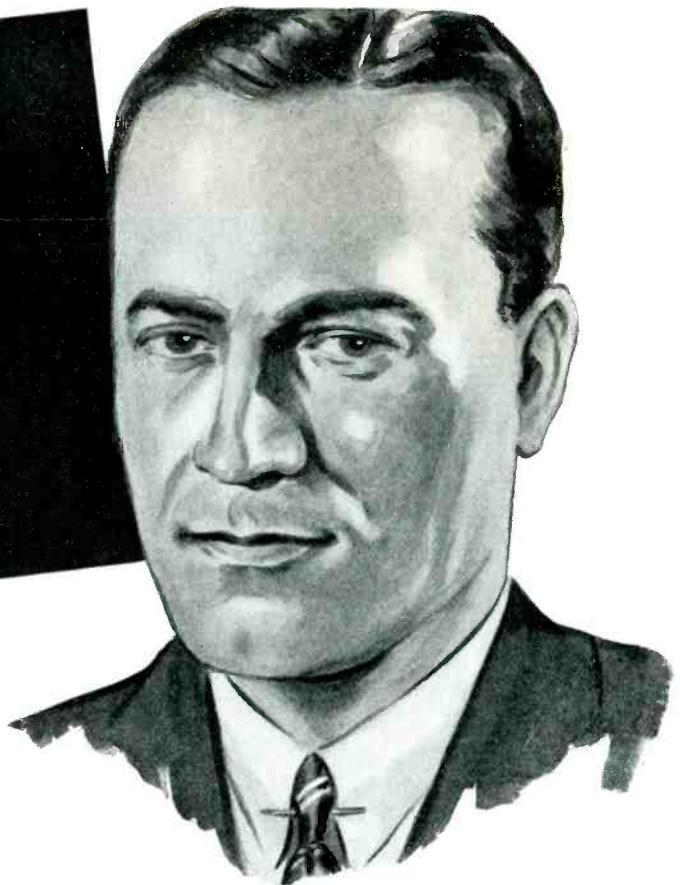

IT'S your business to sell radios. It's my business to help you make more sales and more profits. I'm an expert at that. I have helped sell billions in merchandise to millions of families.

Many of the families in your community are my friends. I helped them when they bought their automobiles, their oil burners, heating equipment and many other appliances. They liked my way of doing business. When they find I am working with you, they will be more willing to buy from you.

When you and I work together, my business broadens your

prospect list and makes your customers appreciate your services. My methods are tactful, effective, sure, yet never embarrassing or offensive. You concentrate on selling. When the sale is made, you get your money promptly.

Let me show you how I can make more profits for you. I am the manager of one of the 195 Commercial Credit offices in the country. One of them is in your territory Get in touch with me today and let's talk it over.

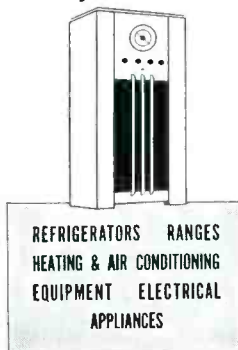

COMMERCIAL CREDIT COMPANY

COMMERCIAL BANKERS
CONSOLIDATED CAPITAL



HEADQUARTERS: BALTIMORE
AND SURPLUS \$65,000,000

SERVING MANUFACTURERS, DISTRIBUTORS AND DEALERS THROUGH 195 OFFICES IN THE UNITED STATES AND CANADA

AGAIN *Motorola* LEADS

PUSH-BUTTON NETWORK TUNING

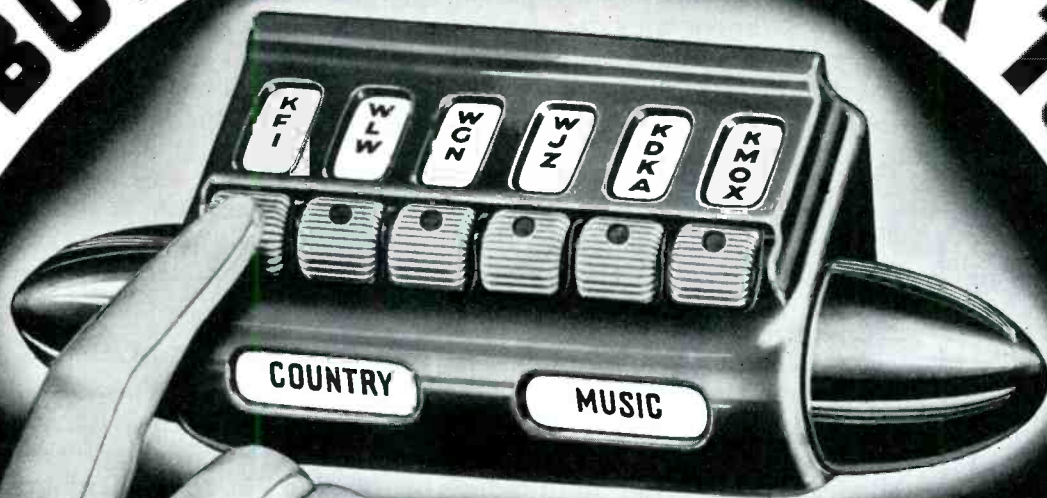

6 COLORED
NETWORK
BUTTONS

PUSH A BUTTON
Get Your
Favorite Station
Automatically

ON THE
FAMOUS
ACOUSTINATOR

ELECTRIC • AUTOMATIC • COLORFUL

SEE YOUR
MOTOROLA
DISTRIBUTOR

Motorola
AMERICA'S FINEST AUTO RADIO

SIX "ACE"
FEATURE
MODELS
\$29⁹⁵ to \$79⁹⁵

GALVIN MANUFACTURING CORPORATION • CHICAGO



HARRY BOYD BROWN
*National Merchandising
Manager of Philco*

"THE RECORD SPEAKS FOR ITSELF"

WHEN the going gets tough, the radio dealers of America know they can depend upon the strong, steady public demand for Philco. They also know that they can rely on Philco Leadership. History proves it. And history is repeating itself in 1938—because Philco national advertising for this Spring Season will continue in tremendous volume without interruption.

The country is in the midst of a general business depression. It should be of short duration. At least most people think so, and all signs indicate it. The basic economic situation is good, and it seems possible for business recovery to be built up quickly.

However—depression or no depression, good times or bad—the radio dealers can depend upon Philco. The record speaks for itself. For more than 8 years—through days of national prosperity and on through the darkest days of business depression—Philco has carried on the most gigantic, the most consistent advertising program in radio history. And Philco is not changing from that program of action one iota today.

Remember also—that more than 30 million radios are in use in the United States today in home and automobile. They are an absolute necessity. The American public cannot live without them. And they are wearing out by the millions. They are becoming obsolete by the millions.

The replacement of these millions of worn out and obsolete squatter-type radios is inevitable. The less that are sold today because of business uncertainty, means the more will be sold tomorrow. Postponed purchases—millions of them—will rapidly blossom into sales as business recovery moves ahead.

That is why Philco advertising will carry on in ever increasing volume. And 7 out of every 10 people—who ask for any particular radio—will continue to ask for Philco—the radio with the Inclined Control Panel which means "No Squat! No Stoop! No Squint!"—the amazingly popular slogan that has put Philco on the tip of everybody's tongue.

Millions of people of all ages and in all walks of life, are absolutely sold today on Philco, and Philco will be their next radio whether they buy today—tomorrow—next month or next year.

Harry Boyd Brown

PHILCO

The

RADIO MONTH

JANUARY

1938

First Clear the Deck Indications are that some manufacturers, distributors and dealers have entered the new year with exceptionally large stocks of sets. Strenuous means and perhaps drastic measures will have to be employed to unload those stocks on the public before summer when the new annual lines are announced.

Such being the conditions, this seems to be the appointed time for dumping the mid-season-model idea overboard. If ever there was a time when the industry needed to concentrate all its appropriations, all its ingenuity, all its sales talent behind the effort to move already-made sets and already-advertised models it certainly is now. New mid-season models would only create new burdens, divided promotions, divided sales effort and could produce no more than divided results.

Instead of scattering the shots why not put all possible effort behind the models which up to October gave us record-breaking sales. Then let the new annual models come at the usual time.

Why Not? Top floors of the highest buildings in some cities recently have attracted new tenants, whose family tree somewhere or other runs back to one of the local broadcasting stations. Reason? To have an ace in the hole if and when commercial television broadcasting becomes practical. The higher the transmitting antenna, the greater the effective radius.

Said one prominent broadcaster: "A whole new industry lies in the lap of radio but only a handful of concerns are experimenting. Some broadcasting stations are piling up big profits, are paying big taxes. Why don't they spend some of their dough for video transmitters, get into the running by

experimenting with television studio and transmitting technique. If ten, twenty, a hundred broadcasters jumped into this thing, progress would be that much more rapid. Why don't you get busy pushing the idea?"

Here is our "push" and we remind anyone who wants to get busy now, that they probably would have to wait 9 to 12 months to get delivery on transmitting equipment. Line forms at the left.

Dealer Unrest Among the dealers to whom we have talked in recent months were many who expressed genuine dissatisfaction with their present leading set line. Quite frankly, they stated that they were going to switch and feature some other brand—"just as soon as our stock of X sets is down so we can afford to do it."

When reasons were asked for, a number of different explanations resulted. On the surface none seemed identical, yet when traced down they led to one common cause namely—those dealers had been oversold at the beginning of the season and did not have the shock-absorbing fortitude to stand pat when sales slumped.

They blamed: too many models, trick tuning, high list prices, the fair trade trade-in puzzle, too large quotas. If they had been short of sets—instead of overstocked—perhaps some of the same factors would have been blamed.

Fact is, the value of a dealer franchise for any reputable set does not fluctuate violently. A dealer who switches after having pushed a certain brand for some time simply is giving one of his competitors—or a newcomer—a chance to lick up the gravy of his own effort. The moral is—stick by the manufacturer who has treated you right. The rolling dealer gathers little profit.

Be Thankful Often we hear complaints about advertising plugs or announcements during sponsored broadcast programs being too long, about them spoiling the show, interfering with its proper enjoyment. We have heard many kickers wishing that we had "the same system they have on the other side" meaning, generally, Great Britain.

Now evidence appears that even Britain itself does not entirely like the dish that its government-operated British Broadcasting Corporation serves up. In a poll taken by an important radio manufacturer and covering over 5,000 dealers in all parts of the British Isles the station which drew 95.6 per cent of the votes as the favorite station was not a BBC unit but Luxembourg, a commercial station located on the Continent and sending out sponsored programs. Britain's premier station, Droitwich, stood THIRD with 74.1 per cent and the London National program stood at 12.3 per cent in this popularity poll.

The manufacturer who sponsored the poll charges: "We indict the BBC and its program policy as the root cause of the sales slump which is now threatening the existence of the whole of the radio trade."

That's in England.



EDITOR

Here's Where You Can Increase Sales

Now

FARM INCOME RISES 743 MILLIONS IN NINE MONTHS

Washington, D. C., Nov. 9.—(P)—The bureau of agricultural economics reported today that American farmers received approximately \$743,000,000 more from the sale of principal farm products, and from government payments during the first nine months of 1937, than during the same period last year.

from Chicago Tribune,
November 9, 1937

LATEST government releases from Washington report that American farmers have more money to spend today than at any time since 1929 . . . farm income up 743 millions the first nine months of 1937.

There's the market to shoot at. Remember, 5 out of every 6 American farms have no electric service — so it's gasoline powered washers, as well as other gasoline powered equipment, that they are going to buy.

Government reports also indicate that rural electrification is moving slowly — and it will be many years at least before any material number of additional farms will be on hi-lines.

So there's your market — but these orders won't come to you — you'll have to go after them. By all means display models of gasoline powered equipment on your floor and in your windows — demonstrate them to every customer who comes in your store. Orders will be easier to get if the equipment you sell is powered by a Briggs & Stratton motor.

One million of these world-famous 4 cycle gasoline motors, now in use on American farms, have earned the respect and confidence of your farmer prospects . . . Sell where the money is — out on the R. F. D. routes!

BRIGGS & STRATTON CORP., Milwaukee, Wisconsin, U. S. A.

This Selling Statement for the Prospect Who Expects a Hi-Line Shortly

There is no need for him to wait for the conveniences and comforts of modern appliances. He and his family can have them right now.

Then, if the hi-line comes, these gasoline powered appliances can be changed over for electricity at small expense, and the gasoline motors used elsewhere on a great many jobs on the farm.

A Timely Suggestion: Now's the opportune time to reach your farmer prospects. See your Postmaster about placing advertising matter — furnished you by manufacturers of gasoline powered equipment — in every R. F. D. box in your territory — without addressing or stamping.



SERENADE in the NIGHT

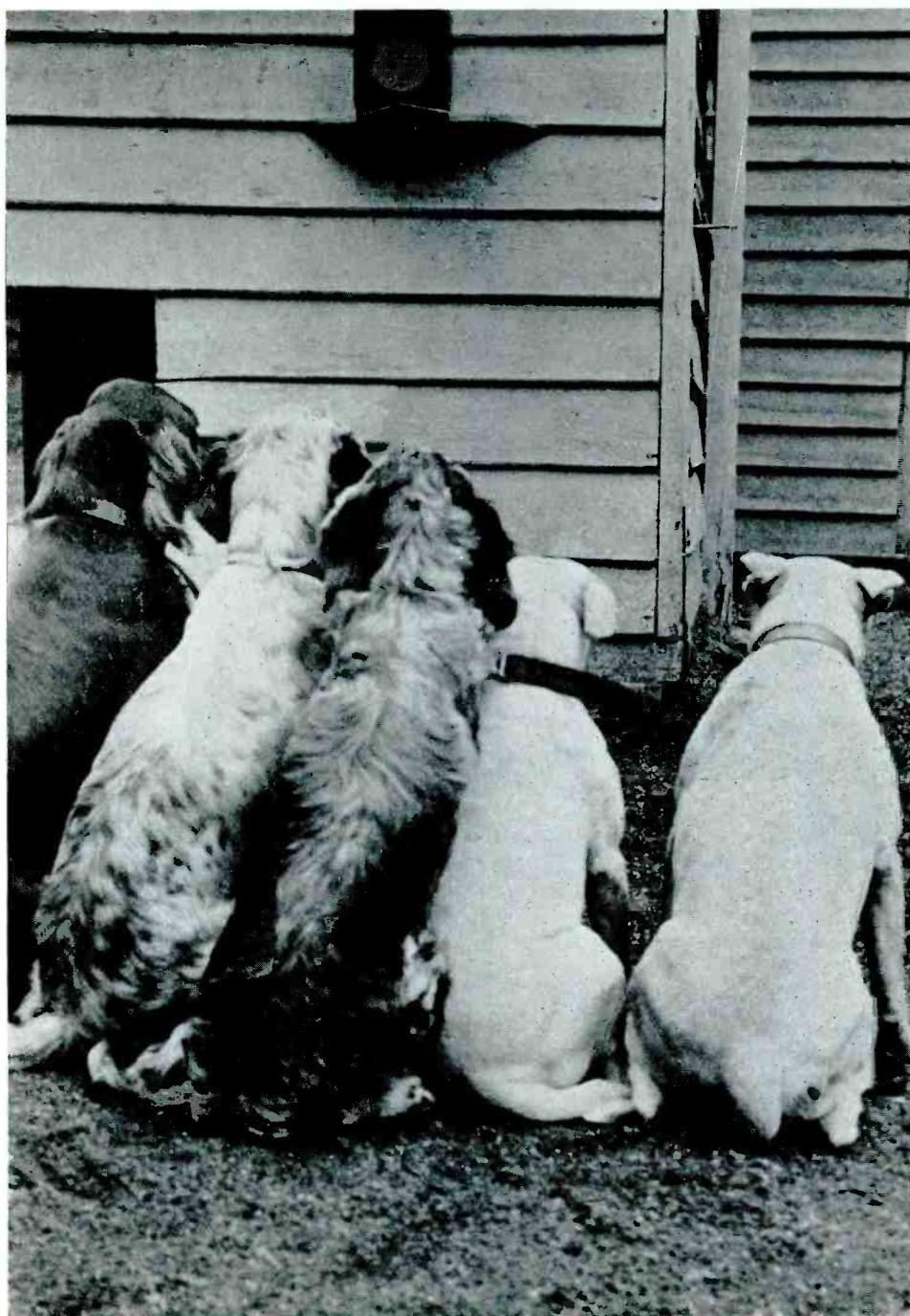

TO men who keep kennels good dogs mean money. Should an animal get sick in the night, attendants too distant to render immediate veterinary service, death might result before morning.

Simple safeguard adopted by this fancier was installation of a Philcophone inter-communicator, bedside to barns. Turned on when he retired, it paid for itself when a valuable English setter coughed, strangling, woke him up. Quick removal of a bone wedged in the throat of the animal saved her, plus a pedigreed litter.

Further use for the system and one which will appeal even to laymen who keep animals merely as pets is its owner's ability to quiet the dogs from his bedside when they bark at night.



42 INTER-COMMUNICATORS, 12,000 FEET OF WIRE

From a dormitory in Slater Hall, Brown University, students "broadcast" plays, news flashes, glee-club and orchestra recitals, talks by the faculty, to all residence halls on the college campus, three fraternity houses, the social center and chapel. Idea originated with freshman George Abraham and classmate David W. Borst, who hope to expand their novel network to 100 outlets by spring. Planned are remote pickups from gym and athletic field



BIG CITY'S BIG SET

Celebrating production of the ten-millionth Philco, simultaneously promoting sales in a practical way, this concern's New York distributor made a 12-ft. reproduction of model 116X, mounted it on the back of a Mack truck, drove all over the metropolitan area. Complete in every exterior detail, the replica virtually stopped traffic at main intersections

SELECTIVITY PROVEN

To prove that the set he featured would tune out the local broadcast station, get through on shortwaves to dx, E. J. Ryan, sales manager for the Russell Electric Company of Tucson, Arizona, took one up on the station's roof, demonstrated its ability to the press. Result: Much favorable publicity in the local prints, an increase in sales. Took photograph of demonstration, used it effectively in advertising

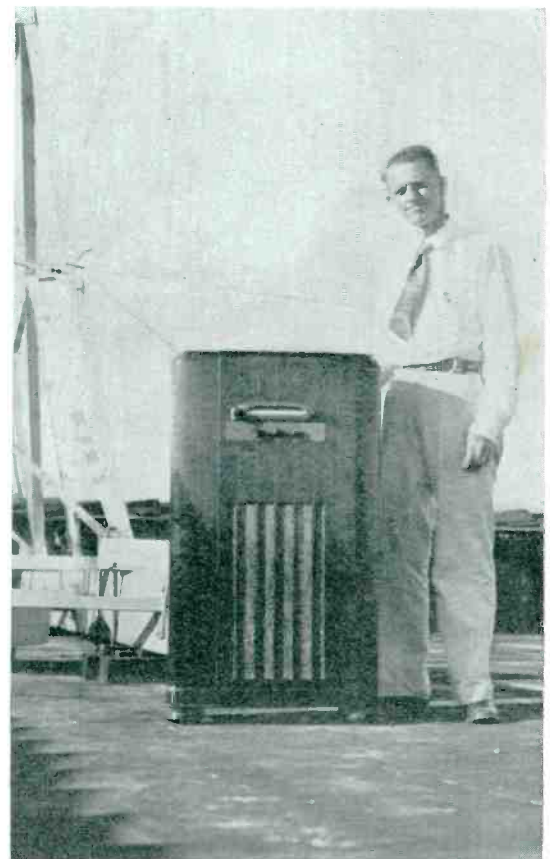



LESSON IN DISPLAY

Western Auto Supply of San Francisco uses this effective corner arrangement for radio. It's built "L" shaped, of plywood. Eight feet high, the cabinet has a 30-inch canopy for indirect lighting. Exterior is a deep tan, striped with modernistic silver mouldings. Corrugated paper forms the interior. Words at top are illuminated



ELMER HAYSEED GOES TO TOWN

A professional actor, hired by Mosier's of Mamaroneck, New York, bearing a sign "I'm looking for Mosier's", wandered all over town. A crowd followed him to the store, watched him plank himself down in a chair outside, then push the buttons of an RCA remote-controlled radio. Cost... \$15.25 plus a case of poison-ivy picked up while gathering decorations

DEALERS PER TOWN

Charles R. Harrison, radio head for Detroit's G.E. Supply, thinks leading lines should have about the following distribution: Towns of 1,000 to 5,000—1 dealer. 5,000 to 10,000—2 dealers. 10,000 to 25,000—3 dealers. 25,000 to 50,000—4 dealers. 50,000 to 100,000—10 dealers. 100,000 and over—25 dealers

SERVICE FOR THE STICKS

Layout of a trailer for servicing sets in the suburbs, suggested by Indian Trailer and Supreme Instruments, includes every conceivable convenience. From this photo we suspect that a lesson in compactness may be learned even by men who operate shops "off wheels". The other end of the trailer is laid out as a comfortable waiting room



RADIO RETAILING, JANUARY, 1938

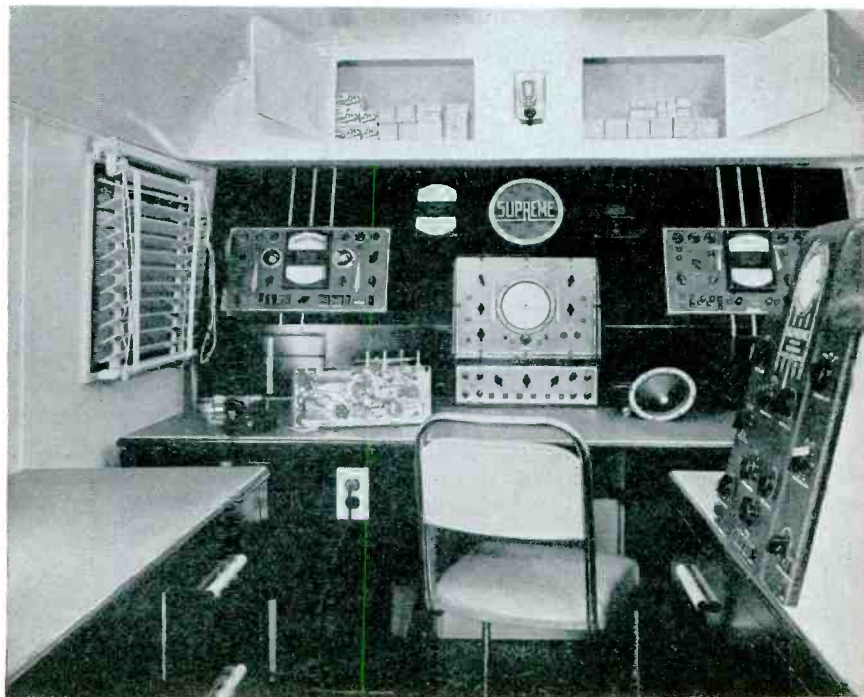

The WAY

IF you want to see a business man with an inferiority complex, all you have to do is look at the average radio retailer. He is as indispensable in the modern scheme of things as the milkman or the grocer and yet he is content to appear as a cut-rater, as if customers could only be lured to his shop by the announcement of super-stupendous bargains. Strangely enough, he does everything in his power to encourage this idea. He advertises long lists of price specials in the newspapers. He keeps his windows full of marked down values. He even enters into competition with the corner drug store and its low priced sets.

The worst of all this is that he has sung the old sparrow song of "cheap, cheap, cheap" for so long that his audience has come to believe him. Mr. and Mrs. Public, well trained, now go into the market to buy a radio in the old horse trading mood of Give-me-a-bargain-or-I'll-walk-home.

There was some excuse for this state of affairs in the past. The radio industry was very young. It was developing with amazing rapidity and frequent and radical improvements threw much distress merchandise on the market. But now conditions are better. While changes undoubtedly will continue, the industry is turning out a good product, that will not become obsolete over night.

This, then, seems to be the time for the radio industry to end the price war that has been in progress for so many years, to scrap along with it the old cut-rate methods, and to try new ones that will tempt the feminine public with a real incentive to buy. Any number of industries

PAINT A PLEASING PICTURE—Glorfy really good things and appeal to her vanity, pride of ownership . . . convince her that the merchandise you recommend will

be envied by her friends . . . tell her that men will appreciate her taste . . . and she will find a way to pay for it even if this means going on a diet

To Sell WOMEN



By
MARY DAVIS GILLIES

*Home Furnishing Editor,
McCall's Magazine*

have found out the secret of doing this. For instance,

How do you suppose electric ranges and automatic refrigerators costing \$150 to \$200 are being sold—and sold easily and painlessly? Why do you suppose every woman in the country is hankering for new major kitchen appliances? Why, to cite an extreme but by no means rare case, do girls put off marriage until they can start housekeeping with a beautiful, shiny, streamlined electric refrigerator placed in a kitchen that will maintain the style to which it is accustomed? Is all this because of special price promotion? Not at all. It's because the electric industry, working cooperatively, has made the kitchen glamorous. It has performed the really remarkable feat of convincing women the length and breadth of the land that with these new gadgets cookery and food stor-

age take on more breath-taking fascination and allure than a Clark Gable movie or a trip to a beauty parlor for a permanent, a facial and all the items on the list.

How sad to turn now and inspect the average radio dealer's effort to give his product "umph" or glamour! Instead of a siren call, his display window, filled with distress merchandise at special prices, is more like a cry for help.

And note how Mrs. Public responds. The window alone tells her that here is a place to get a bargain. As she clutches her pocketbook more firmly, sallies into the store and looks around, everything increases this conviction. The place is a hodge-podge of radios—row after row of them, shelf after shelf. The salesman advances, ready to entertain her with some light chit-chat about all-wave

sets, kilocycles, 10-watt output, automatic frequency control, tuning indicator and inter-station noise eliminators. As a special treat, he may even show her an 11-tube a.c. super-heterodyne that covers five bands.

Now there may be super-women equipped to grapple with these subjects but if they do exist we've never met them. Probably they'd assemble their own radio sets anyway. Be that as it may, the one-way conversation noted above is simply not suited to the feminine mind. As a sex we have only two reactions to it. One is to say "Thank you" and totter out of the store. The other, if we absolutely must have a radio and can't go home without it, is to pick one blindfolded as it were, not knowing whether it is good, bad or indifferent and entirely missing the

(Please turn to page 59)



CONCENTRATE ON QUALITY—If you talk price or technicalities the bright, spendthrift mood will fade into drab, remember—the budget caution

to **BIG BUSINESS** *from* **LITTLE BUSINESS**

-- 5 letters about *industrial discounts*

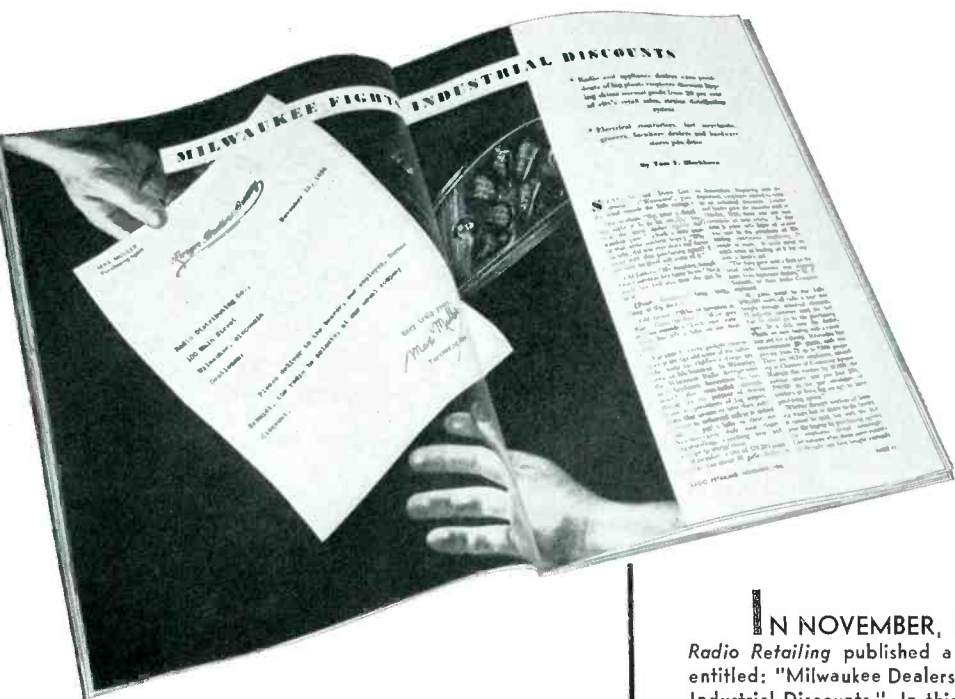

LETTER No. 1

Only one man told us we were wrong. All the others who wrote in promised to try to remedy a situation which is causing much mental anguish among the hundreds of retailers in town.

And many who did not write us . . . phoned their willingness to cooperate.

This year we are again asking your help to stop a form of "We'll get it for you at wholesale" that is depriving the legitimate retailer of considerable business.

In many of the industrial plants throughout the city, group and cooperative buying opportunities are offered to employees. This offer is made in sincerity . . . but this helping hand reacts unfavorably for a whole group of men and women whose livelihood depends upon the maintenance of a price structure.

Won't you kindly investigate just what steps are taken in your organization to protect the retailer.

LETTER No. 2

Please pardon absence of the personal letter idea in this follow-up to our recent letter to you . . .

IN NOVEMBER, 1936, *Radio Retailing* published a story entitled: "Milwaukee Dealers Fight Industrial Discounts." In this story 5 letters sent to big local business concerns, urging them to discontinue the practice of purchasing radios and appliances for employees at wholesale, were reprinted. Co-authors of these unique and effective letters were Frank W. Gruesel and H. L. Ashworth, president and executive secretary of the Wisconsin Radio, Refrigeration & Appliance Association.

As recently as November, 1937, one full year later, requests for additional details continued to be received. And in November, 1937, we printed a note in our News columns stating that a new series of letters had just been prepared and mailed by Messrs. Gruesel and Ashworth.

So great has been the demand for copies of these new letters that we print them, in full, in the following columns.

The American Mercury and the Readers Digest told millions that . . . "Only Saps Pay Retail".

It was an illuminating article . . . and cast some good natured fun and satire on an

evil that is daily making it more and more difficult for the small merchant to exist.

In fact this evil has grown to such proportions that some large industries are going out of their way to buy many types of merchandise for their employees at wholesale, including electrical household appliances of various kinds.

This organization appreciates the altruistic motives that prompt this form of employee-help, but it bemoans the fact that the continuance and growing practice of this type of buying will soon seriously jeopardize the very existence of these small merchants who would otherwise get this business.

At first thought that might not seem to be a serious loss to industry . . . but by the inevitable cycle of business activity this loss would re-act to industry's disadvantage.

When everyone is prosperous . . . industry prospers.

Won't you check with your own people as to the prevalence of this practice in your organization?

LETTER No. 3

" after the ———— Plant had shut down almost the entire business of the town was paralyzed."

How often have you read such accounts in the papers? Loss of income in a plant means loss of income to all the hundreds of shop keepers in the neighborhood.

I can hear you asking . . . "What have I to do with that?"

Just this . . . that when you permit or encourage your employees to buy retail commodities (radio-refrigerators-wash machines-tools-garden implements, etc.) at wholesale through your own buying facilities, you are creating just such a condition in the neighborhood of your plant.

Perhaps you have been far-sighted enough to see the wisdom of refraining . . . in which case this organization thanks you.

In case, however, that you are fostering or permitting such buying activities in your organization, we respectfully ask that you reconsider this move.

The retailer who performs a definite and necessary service in the community cannot exist in the face of your own competition. Give this merchant a chance to live . . . to prosper . . . and in turn to help

(Please turn to page 59)

KADETTE *Greets 1938*

with 5 Completely New Models!

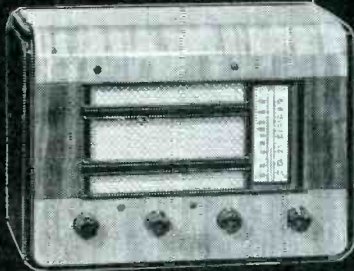

Model 630 \$29.95

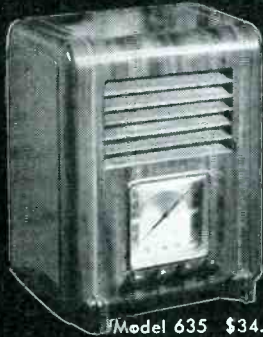

Model 635 \$34.95

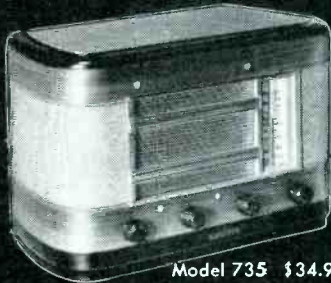

Model 735 \$34.95



Model 950 \$46.95



Model 845 \$44.95

Kadette Radio achieves another outstanding triumph with the introduction of five sensational new, custom built models. Startling in beauty, outstanding in performance, these superb new models mark the beginning of another great Kadette year.

- ★ Model 630 is a 6-tube dual range, AC superheterodyne receiver featuring the new illuminated Kadette Thermodial[®], tuning standard broadcast and the more consistent foreign and domestic short wave stations. Cabinet is of "roll-front" two-tone mahogany with mahogany-finished hardwood ends.
- ★ Model 635 is a superior 6-tube, AC superheterodyne receiver tuning standard broadcast and the more consistent foreign and domestic short wave stations. Cabinet is of Oriental wood and American walnut with vertical inlays.
- ★ Model 735 is a distinctive lay-down cabinet with Thermodial[®] combining the highest quality walnut veneers with unique cork inlays. Its polished die-cut copper plated escutcheon and speaker grille give it an outstanding appearance. Tunes same bands as Model 635.
- ★ Model 950 is an all-wave AC superheterodyne receiver with nine tubes in a cabinet of selected veneers and inlays, combining cherry and burl walnut. Cathode ray type tuning eye assures perfect tuning and fidelity of tone.
- ★ Model 845 is a magnificent 3-band, all-wave AC superheterodyne receiver. Its eight tubes make it one of the most powerful receivers in the Kadette line. Cabinet of beautiful satin-grain walnut with burl top is large enough to provide over-size speaker and baffle, producing unexcelled tonal quality.

It is truly a Five Star Line! Created to standards requiring the finished work to remain forever an exquisite example of craftsmanship—designed to provide definite assurance of spring volume and profit for YOU. Phone your jobber—TODAY!

INTERNATIONAL RADIO CORPORATION
565 Williams St. Ann Arbor, Mich.

*Patents applied for.



KADETTE

*Creators of
Quality
Compacts*

Do We NEED a **NATIONAL ASSOCIATION of Radio & Appliance Retailers?**

By O. FRED ROST

RECENT months have brought forth an unusually large crop of requests for information on association activities. Individual dealers and well-managed local associations are asking more frequently and with increasing insistence: Why don't we have a NATIONAL association of Radio men?

Well! Why don't we?

As far as we can see, the answer to that question is like an open book only—it appears—too few radio dealers have taken the trouble to look at the open pages.

Obviously it is entirely a matter of who and how many dealers in various parts of the country are willing to cooperate, put their shoulders to the wheel, spend some of their own time and money, to enlist the necessary numerical and financial support for such an organization and then follow the necessary procedure for calling such a National association formally into being.

However, before any steps are taken in that direction, it seems desirable that all concerned should give proper and serious consideration to all the problems involved and analyze the situation from every possible angle.

What Other Industries Have Done

It must be admitted that many well known facts favor the plan for a National Association of Radio and Appliance Dealers.

For instance, it can be said without fear of contradiction that no National association of men engaged in the same or allied lines of business has ever done any of its members

or the public any harm—as long as it operated within the law—but, to the contrary, in most cases such organizations have accomplished untold good for all concerned.

Furthermore, the records of accomplishments of such organizations in other lines of retail trade support emphatically the contention that National cooperation in addition to local group action is essential and almost indispensable for protecting wholly the interests of all members of the trade.

While space does not permit the publication at this time of a record of specific performance of important

associations in the retail distribution fields, the latest available record of their membership enrollment seems to supply all necessary testimony of their usefulness for retailers cannot afford to support such effort unless they know they get more out of it than they put in.

Here is the list of the most important national associations of retailers.

American National Retail Jewelers Association.....	2,708 members
National Association of Music Merchants.....	1,000 "
National Association of Retail Druggists.....	22,000 "
National Association of Retail Grocers.....	23,000 "

WHAT IT MIGHT ACCOMPLISH . . .

AID in the immediate solution of problems such as the handling of trade-ins within the structure of fair-trade law objectives.

COMBAT persistent evils requiring national attention, such as continued buying at wholesale discounts by the consumer.

GIVE the retailer a voice in the event of proposed discriminatory taxes or laws adversely affecting merchandise sales.

FACILITATE the formulation and execution of broad promotional plans intended to promote profit for all retailers.

AID the trade in its relations with manufacturers and distributors of radio and allied equipment.

National Association of Retail Meat Dealers....	50,000 members
National Auto Dealers As- sociation	6,000 "
National Retail Furniture Association	4,300 "
National Retail Hardware Association	21,000 "

To view those impressive figures quite naturally raises the question: Why? Why, for instance, should 50,000 meat retailers, 22,000 druggists, 6,000 automobile dealers pay annual dues into a national association when most of them get 99 per cent of their business within a few city blocks or a few miles of their establishment?

The answer is: Those retailers have learned to realize that even though their business is strictly *local*

and broadly in recent years. Therefore it has become increasingly important for local interests to keep an eye on and take part in any discussions at Washington or elsewhere that are national in origin and character but exert a definite and often serious influence upon local business practices. Since no lone retailer can do this without going broke, a national organization can and generally does protect his interests at a small cost to each member.

The same broad principle of united action for the benefit of the individual members holds good in affairs that are intra-state or pertain to a particular community. In such cases the weight of an organized group always produces more satis-

general and broad observations on the "pro" side must suffice.

Let us therefore proceed to a consideration of the problems involved or rather to a cold blooded appraisal of the responsibilities that the industry must expect to assume if it wishes to create and keep alive such a National organization.

All Branches Must Be Considered

It must be agreed at the outset that it would be better to have no national association at all than to have one that is other than fully representative, properly organized and staffed, and sufficiently well financed to become the active, militant and unanimous National voice and representative of its members. To fill those specifications is no easy job.

For instance, the need to have it fully representative of the trade cannot be easily satisfied. There are in existence today many well organized and efficiently operating local or regional associations of radio or appliance dealers and a large number of electrical leagues. Those units should logically provide the framework around which a national association is built.

To have those groups and their members take an active and lasting interest in a national organization will demand that the constitution and by-laws of the latter insure every local group complete and unqualified autonomy and yet offer them certain definite and clearly defined inducements that will make their identification with a national group indispensable, advantageous and profitable so as to more than offset whatever the nominal cost of such affiliation may be.

The set-up of the national organization also would have to make suitable provisions for proportionate representations of all the different groups within the trade. Consideration would have to be given to the question whether membership should be made attractive only to retailers who deal chiefly in radio and appliances or whether associate membership should be available to automotive, furniture, hardware and other retailers who also handle those lines.

Then there is the question of the radio and appliance service shops. There are thousands of men in that field. They may not handle any new merchandise directly but their policies have a definite influence on the

(Please turn to page 80)

ORGANIZATION OBSTACLES . . .

DIFFICULTY of inducing enough dealers to give the plan active, tangible and continuous support.

DESIGNING an Association structure sufficiently flexible to adequately serve all branches of the trade.

DRAFTING of by-laws which would attract existing local groups and still leave them free in purely regional matters.

INCLUDING sufficient flexibility to extend a voice to independent retailers not at present affiliated with any group.

FINANCING such an Association in its difficult initial stages and adequately thereafter.

their own future and fortune is constantly and definitely affected by factors that are *national* in origin or influence.

This national influence on the operations, policies and profits of local business men has grown tre-

factory results than if individual members of a particular trade registered their opinions merely as individuals.

As this article is not intended to serve as an exhaustive brief in favor of a national association of radio and appliance dealers, the above few

TELEVISION

and the

RADIO Industry



A Statement by DAVID SARNOFF

*President, Radio Corp. of America
Chairman of the Board, National Broadcasting Co.*

Statements by Sayre M. Ramsdell, Vice-President, Philco Radio & Television Corp., and by William S. Paley, President, Columbia Broadcasting System, Inc., appeared in the December issue. In November *Radio Retailing* published a complete story of Television Retailing in England.

TELEVISION is today an unfinished product. Its progress up to now, and some of the problems which still remain to be solved, are parallel in many respects to the early progress and problems of the motion picture industry. Those who remember the flickering images and the crude scenes of the early films—in contrast to the technical and artistic perfection of present-day motion pictures—can understand what we are up against in getting television in shape to perform a useful public service.

We brought television out of the laboratory and “into the open air” on June 29, 1936. At that time we began transmitting television images from the RCA experimental station at the top of the Empire State Tower, New York City, to receivers in charge of our engineers at selected observation points throughout the metropoli-

(Please turn to page 64)

JUST DELIVERED—These two motor vans, one containing picture and the other sound pickup apparatus, relay important outdoor news events to Radio City, are the latest addition to RCA-NBC's experimental apparatus



now!

ELECTRIC

\$29.95
LIST

TOUCH-O-MATIC

MOTOR TUNING

by Admiral

AT ONLY



**GENUINE
ELECTRIC
MOTOR
TUNING**

“STEP-UP”

PROFITS AT \$39.95

At \$39.95 this new 6-tube Admiral De Luxe Table Model with 6-button fool-proof motor driven tuning is a real bargain. Yet it is priced to allow you an extra generous profit—you can offer a liberal trade-in allowance and still make your usual margin. A real opportunity to “step-up” profits now.

Specifications: Model 103-6B—6-tube AC superheterodyne in streamlined de luxe two-tone walnut cabinet (18" long, 10 1/4" deep, 9" high). 2 bands. Tunes American broadcast and 19, 25, 31 and 49 meter foreign bands, police, amateur, aviation, ships at sea. Full vision 6 1/4" dial; 6-button electric Touch-O-Matic tuner; 6" electro-dynamic speaker; automatic volume control; tone control; special wave trap.

Ask Your Jobber or Write Us.

CONTINENTAL RADIO & TELEVISION CORP.

3800 W. Cortland St.

Chicago, Ill.

A PRICE LEADER TO “BRING 'EM IN”!

Now—electric touch-o-matic tuning at a price to keep sales sizzling in winter months. At only \$29.95 this new 6-tube Admiral Table Model No. 102-6B in handsome walnut cabinet has touch-o-matic electric motor tuning. Just touch any one of the six buttons—in comes a station as swiftly and simply as switching on an electric light. Chassis specifications same as No. 103-6B.

\$29.95



...and, What About FACSIMILE?

By
BEVERLY DUDLEY

TELEVISION is coming around the corner—when she comes. Facsimile broadcast transmission is practically here.

Nine stations in the regular broadcast channel are now licensed for the transmission of still pictures, a tenth application is pending, and five stations in the higher frequency channels enjoy official sanction of the Federal Communications Commission. Indeed, since September when the F.C.C. licensed the first experimental facsimile broadcast stations, such rapid strides have been made in this field that there is good possibility of facsimile receivers being generally available in the home considerably before television equipment. One reason for this statement is that the technical and economic problems do not appear so formidable as in television. Another reason is that as a condition for the granting of an experimental license, each station must maintain a minimum of fifty recorders in its service area in order properly to carry out its experimental program.

With some dozen stations using their night time power and transmitting between midnight and 6 a.m. to some 500 or more recorders throughout the country during the year for which experimental licenses are granted, a good start is being made to introduce the "radio newspaper". Active in the field are four separate research organizations, each with its own facsimile system, so that development is not likely to be frozen along one narrow groove. These organizations are Finch Telecom-

munications, Inc., Radio Corporation of America, Radio Pictures, and Fultograph, Inc.

But it must not be assumed that the "radio newspaper" is here in full bloom, blasting away 24 hours per day, or that picture equipment is generally available over the counter of his local supplier—not yet, anyway. A completely new communications system does not mushroom over night, especially in a country as large as the United States. There are many problems to meet; many questions to answer before a satisfactory facsimile broadcast service is an accomplished fact.

For example: What types of programs and services will be available? Will a facsimile receiver be able to reconstruct pictures from all stations within its range or will it be limited to reception from one station? Will a new radio receiver be required for facsimile or will the recorder be attached to existing radio receivers? Can sound and facsimile be received simultaneously on the same receiver? How much will facsimile receivers



BUILT-IN RECEIVER—To New York's police commissioner Lewis Valentine (left), NBC's Lenox Lohr demonstrates RCA's latest experimental facsimile receiver

cost? How will they be merchandised? Will they be difficult to operate, maintain, and repair? Who will pay for facsimile?

The last question can be answered immediately. No matter how you disguise it, John V. L. Public is going to pay for facsimile in the last analysis, just as he now pays for radio. He may do it through purchasing sponsored products, he may do it by entering contests and submitting coupons or "reasonable facsimiles thereof;" he may do it in other ways. The final outcome is decided; only the technique of anaesthetizing the bill remains to be worked out.

Some of the other questions cannot be disposed of quite so readily.

For the present, most programs will be limited to transmission between midnight and 6 a.m. Whether this period of facsimile transmission will ultimately be extended depends

to a large extent upon the field tests obtained during the year of experimental operation and the demand for facsimile. So far as program material goes, greatest possibilities at present lie in the direction of offering news flashes, halftone pictures, weather maps, and similar items of current interest. Since this type of material is similar to that carried in the morning newspapers, the broad-

ning speed, etc. Such standards are in the process of formulation at the present time, but until they are es-

tablished, no nationwide use of facsimile need be expected. But it is much more traditionally American to establish a system in which receivers are able to pick up all facsimile transmissions than only one or two.

Whether the facsimile recorder will require its own receiver or whether it will use the normal broadcast receiver for signal pick-up is a matter on which there is a difference of opinion. With good cause, one school of thought inclines toward the use of a separate fixed-tuned receiver feeding the recorder. With equally good cause, and perhaps more with an eye toward greatest sales, another school sees no reason why the normal broadcast receiver should not be put to work building up pictures by plugging a recorder instead of a loud speaker into the output.

It is safe to say, however, that with existing methods of broadcast communication, the same receiver could not be used to receive sound and visual images simultaneously. And when one considers the time limitations of facsimile, about the only one who would be interested in such reception might be a night watchman.

As for cost, facsimile recorders can now be sold in lots of 50 or 100 at a price of about \$100 to \$150. On a quantity production basis, the present estimated price may easily drop

(Please turn to page 63)

Licensed Stations

STATION	LOCATION	FRE- QUENCY IN KC.'S
KSD	St. Louis, Mo.	500
KM	Fresno, Cal.	580
WCLE	Cleveland, Ohio	610
(Application pending)		
WSM	Nashville, Tenn.	650
WOR	Newark, N. J.	710
WGN	Chicago, Ill.	720
WHO	Des Moines, Ia.	1,000
WHG	Newport News, Va.	1,310
KSTP	St. Paul, Minn.	1,460
KFBK	Sacramento, Cal.	1,490
W9XAF	Milwaukee, Wisc.	41,000
W9XAG	Milwaukee, Wisc.	1,614
		2,398
		3,492.5
		4,797.5
		6,425
		8,655
W7XBD	Portland, Ore.	1,614
		2,393
		3,492.5
W2XR	Long Island City, N. Y.	1,614
		2,012
		2,398
		23,100
		41,000
		86,000-400,000
W1XMX	Quincy, Mass.	41,000

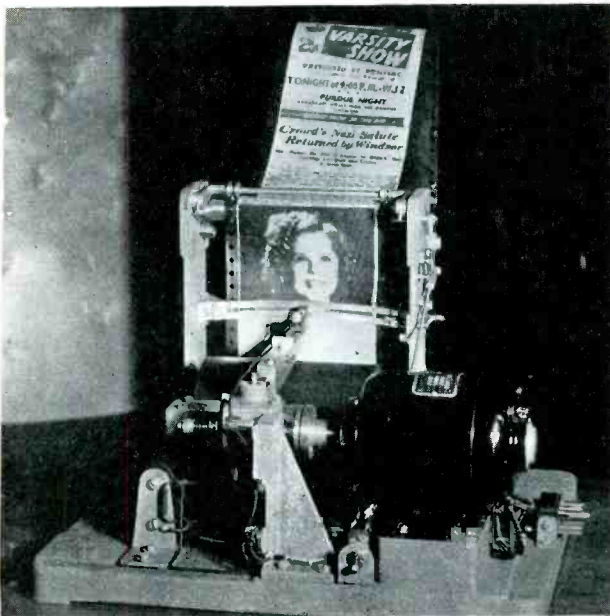

TYPICAL "WORKS"—Motor driven, this facsimile receiver involves mechanical more than electrical problems, is shown in the middle of a halftone

casters are up against the problem of not competing with the dailies. Since history indicates that one type of communication service has tended to supplement rather than supplant other types, it is quite likely that facsimile will tend to whet the appetite of the average person for reading more detailed accounts in his local paper.

Whether a facsimile receiver will be able to reconstruct images from all stations within its range, or whether it will be limited to the output of one or two stations is a technical problem which may find its answer in this year's experimental field tests. In order to make it possible for all facsimile receivers to receive useful images from all transmitting stations, standards will have to be established on such matters as width of image, number of lines per inch, drum advance per line, scan-



ATOP A RADIO—W. G. H. Finch looks over a sample of his latest model's work, achieved in a lighted room, without liquids or processing



FINISHED STRIP—Photos, drawings, ads and editorials, as they would appear to the user, right off the Finch machine shown at the left



*Make your
tube turnover
more Rapid!*

For a tube turnover that's swift as a mountain brook . . . for an endless stream of profit that pours right into your cash register . . . sell Sylvania's.

If the shelves in your shop are jammed with "sluggish", slow-moving tubes . . . if your customers complain about the quality of the tubes you sell them . . . **YOU'D BETTER WAKE UP!** Switch to Sylvania before it's too late!

A 6-month written factory guarantee back of every Sylvania tube you sell is your insurance against business-killing kickbacks. Sylvania's reputation for quality—coupled with the fact that the public appreciates this quality—is your guarantee of a faster, more constant tube turnover . . . and a quicker profit-realization on every lot of tubes you buy.

Let us show you how Sylvania can make your tube turnover more rapid. For full information on Sylvania's complete line of sales and technical helps, write today to Hygrade Sylvania Corp., Emporium, Pa.

SYLVANIA
SET-TESTED RADIO TUBES

SALES ... 1937

Marketing Statistics and

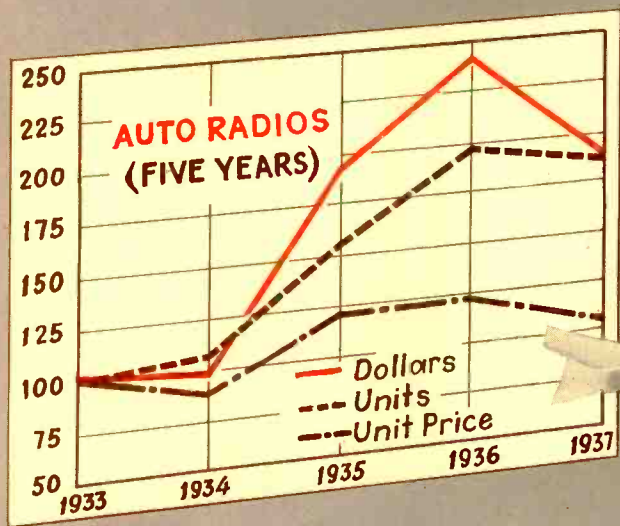
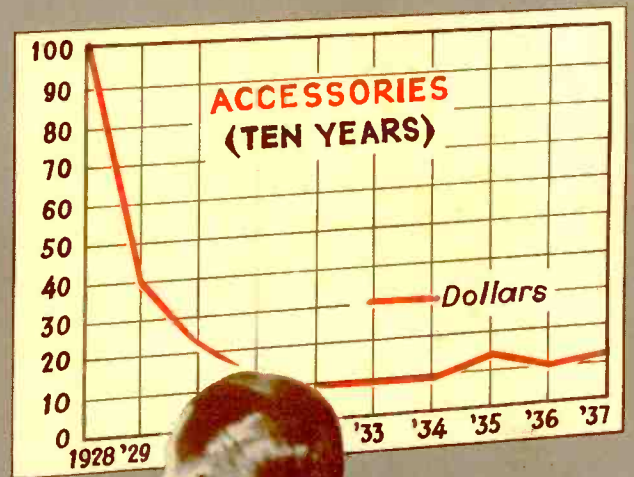
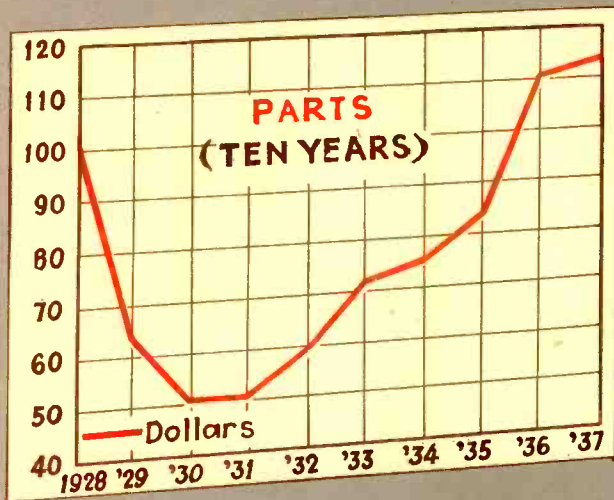
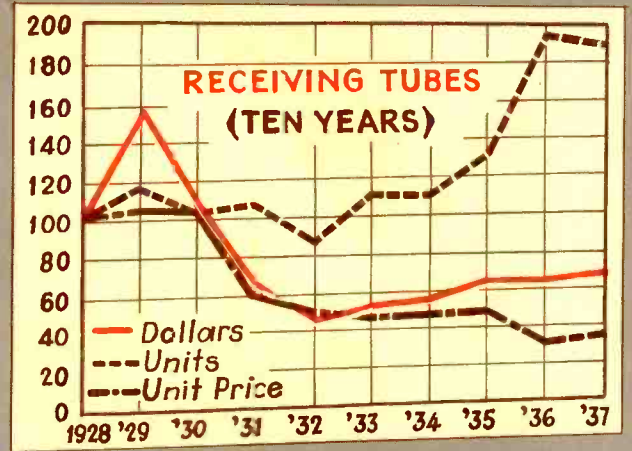
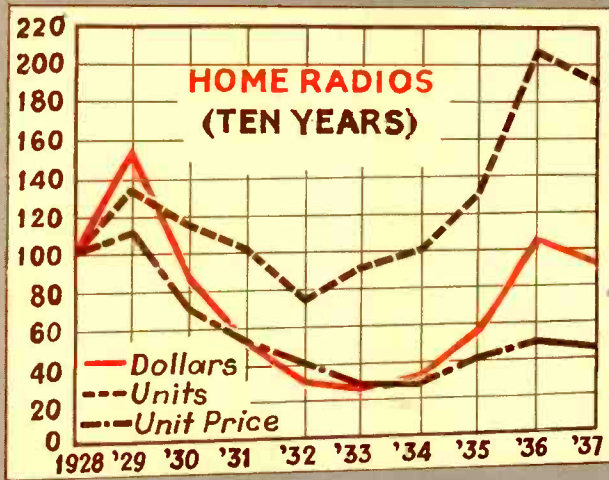

Compiled by Radio Retailing
© 1938

Sets

DOMESTIC SET SALES...1922-1937

YEAR	HOME SETS	RETAIL LIST	AUTO SETS	RETAIL LIST	ALL SETS	TOTAL LIST
1922	100,000	\$ 5,000,000	—	—	100,000	\$ 5,000,000
1923	250,000	15,000,000	—	—	250,000	15,000,000
1924	1,500,000	100,000,000	—	—	1,500,000	100,000,000
1925	2,000,000	165,000,000	—	—	2,000,000	165,000,000
1926	1,750,000	200,000,000	—	—	1,750,000	200,000,000
1927	1,350,000	168,750,000	—	—	1,350,000	168,750,000
1928	3,281,000	388,000,000	Negligible	—	3,281,000	388,000,000
1929	4,435,000	591,543,000	3,000	\$175,000	4,438,000	591,718,000
1930	3,793,800	206,100,000	108,000	5,940,000	3,420,000	212,040,000
1931	3,312,000	329,198,000	34,000	3,000,000	3,827,800	332,198,000
1932	2,477,000	117,710,000	143,000	7,150,000	2,620,000	124,860,000
1933	3,082,000	102,301,000	724,000	28,598,000	3,806,000	130,899,000
1934	3,304,000	122,880,000	780,000	28,000,000	4,084,000	150,880,000
1935	4,375,016	216,590,395	1,125,000	54,562,500	5,500,016	271,152,895
1936	6,746,290	394,819,000	1,412,000	69,188,000	8,158,290	464,007,000
1937	6,278,267	351,690,150	1,353,000	52,767,000	7,631,267	404,457,150
16 YEAR TOTALS	48,034,373	\$3,474,581,545	5,682,000	\$49,380,500	53,716,373	\$3,723,962,045



NUMBER OF WAVEBANDS

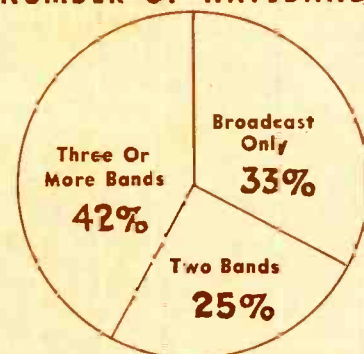

CHAIRSIDE and PUSH-BUTTON

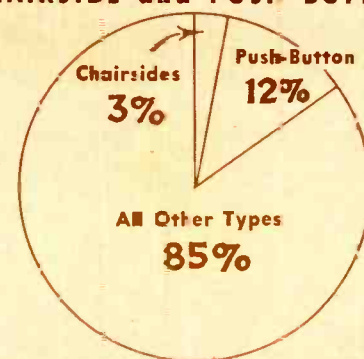

EXPORTS

(Manufacturers)

UNITS	1935
	606,784
DOLLARS	\$16,173,543

and Tubes

RECEIVING TUBE SALES ... Domestic and Export

1935	1936	1937	
75,961,500 Units	105,600,000 Units	103,564,000 Units	TOTAL
43,384,500 Units	55,986,000 Units	53,170,000 Units	REPLACEMENT AND EXPERIMENTAL
\$28,633,700 At List	\$38,058,240 At List	\$38,282,400 At List	
32,577,000 Units	49,632,000 Units	50,394,000 Units	TO MANUFACTURERS

BREAKDOWN BY TYPES

1937 Home Set Sales

BATTERY SETS BY VOLTAGE

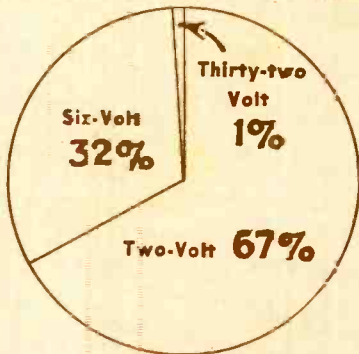

HOME SETS BY MODELS ... Domestic Only

1935	1936	1937	
1,780,631 Units	3,058,768 Units	2,428,122 Units \$208,090,055 At List	Electric CONSOLE Battery
\$121,507,211 At List	\$234,127,667 At List	208,750 Units \$ 12,942,500 At List	
2,594,385 Units	3,611,964 Units	2,952,362 Units \$ 98,313,655 At List	Electric TABLE Battery
\$ 95,083,184 At List	\$146,872,668 At List	626,250 Units \$ 23,171,250 At List	
	75,558 Units	62,783 Units	PHONO-RADIO
	\$ 13,818,665 At List	\$ 9,172,690 At List	

.. ALL SETS

Declared Valuation.

1936	1937
670,800	668,733
\$16,890,744	\$15,562,013

\$53

... was the average price he received for each radio receiver sold

\$84

... went into his cash register for each console model delivered

\$34

... came in for every table-type radio he sent out the door

\$39

... entered his pocketbook every time he moved an auto-radio

Mr.

Average Dealer



20

... used radios, taken in trade, represented his average inventory

\$13.91

... was the average price allowed for each trade-in receiver

11

... of these used radios were eventually re-sold to consumers

\$7.55

... was the average price paid him for each re-sold trade-in

\$146

... was the average price he received for each phono-radio

35

... represented his average new set inventory throughout the year

47%

... were table models, 34% consoles, 18% auto, 1% phono-radios

29%

... of his new set sales were to people formerly without radio



1937

\$13,000

... was the average dealer's gross income from radio set sales

3

... employees worked for him, two full time and one part time

53c

... of his dollar went for merchandise, 28c for salaries

37

... sets were sold by dealers like him while you read these two pages

PARTS

Sales

(These Figures Cover Sales for Replacement and Experimental Use Only)

	1936 (At Mfrs. S.P.)	1937 (At Mfrs. S.P.)	Units
CONDENSERS*	\$1,800,000	\$1,685,000	3,744,500
CONTROLS	\$ 900,000	\$ 755,000	2,068,500
RESISTORS	\$ 850,000	\$ 780,000	10,400,000
TRANSFORMERS†	\$1,500,000	\$1,625,000	
VIBRATORS	\$ 850,000	\$ 840,000	763,750

* Electrolytic and paper only.

† Power and audio.

RELATED ELECTRICAL

	1936
CLEANERS	1,510,953 Units \$67,456,541
IRONERS	180,281 \$10,384,185
REFRIGERATORS	2,079,535 \$341,043,740
SHAVERS	1,222,971
WASHERS	1,528,585 \$100,947,753

*Electrical Merchandising.

TEST EQUIPMENT

Total Dollar Value (at list) of all Radio Test Equipment Sold to Distributors, Dealers, Servicemen and Amateurs

1936
\$3,900,000

1937
\$3,447,000

1937 Sales by Type of Instrument
Total Dollar Value (at list)

TUBE CHECKERS	\$1,025,000
ANALYZERS	\$ 540,000
MULTIMETERS	\$ 410,000
RF-IF OSCILLATORS	\$ 400,000
OSCILLOGRAPHS	\$ 325,000

*Average List Price

OHMMETERS	\$15
OUTPUT METERS	\$ 9
V. T. VOLTMETERS	\$45
A. F. OSCILLATORS	\$65

* Total dollar value not available.

SOUND

1937

Total Dollar Value (at list) of All Complete Sound Systems

1936	1937
\$5,250,000	\$6,950,000

Breakdown of Complete Sound Systems by Types

LINES*

1937 1,740,000 Units \$77,101,500 178,478 \$12,493,460 2,320,000 \$414,400,000 1,580,000 \$25,280,000 1,479,660 \$106,150,808	CLEANERS IRONERS REFRIGERATORS SHAYERS WASHERS
---	--

	1936	1937
PORTABLE AND MOBILE	\$3,000,000	\$3,215,000
LARGE FIXED AND CENTRALIZED	\$1,650,000	\$1,960,000
INTER-COMMUNICATOR	\$ 600,000	\$1,775,000

MICROPHONES (All Types) * 70,000 UNITS

* Breakdown by application, (for sound, amateur, other uses) not available.

ACCESSORIES

	1936		1937	
	Units	Retail List	Units	Retail List
RADIO "B" BATTERIES *	7,500,000	\$10,125,000	7,300,000	\$11,826,000
RADIO "C" BATTERIES *	2,600,000	\$ 936,000	1,457,000	\$ 524,520
6-VOLT WIND-DRIVEN CHARGERS	250,000	\$ 5,500,000	203,000	\$ 4,060,000
32-VOLT WIND-DRIVEN CHARGERS	—————	—————	1,500	—————
6-VOLT GAS-DRIVEN CHARGERS	25,000	\$ 1,500,000	24,300	\$ 1,190,700

* "A" battery estimates likely to be of little practical value as many types designed primarily for automotive or other use may ultimately be used for radio and vice-versa.

RADIO
RETAILING
JAN. 1938

SATURATION . . . JANUARY 1, 1938

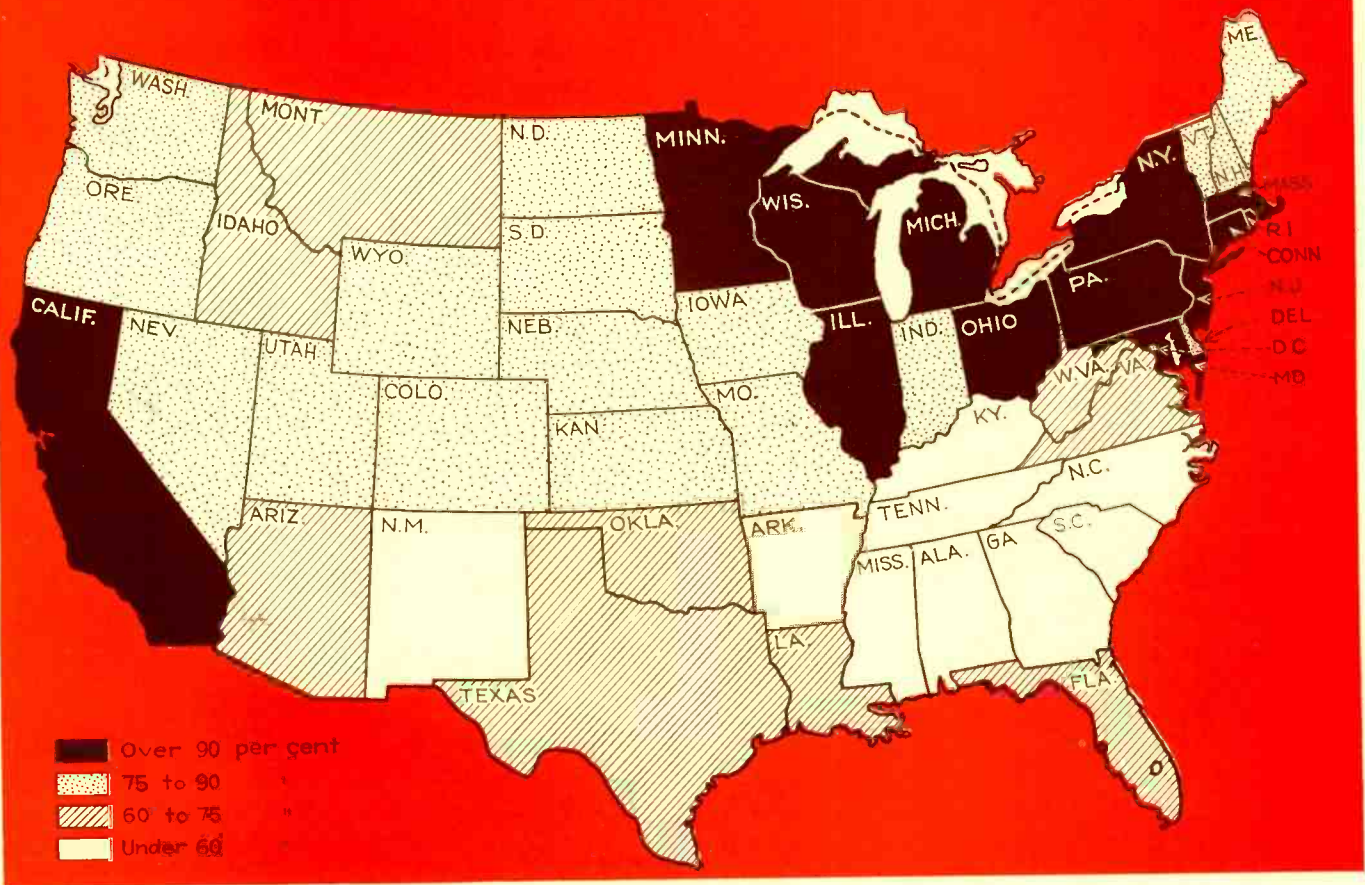

STATE	RADIO HOMES	PER CENT OF TOTAL HOMES	STATE	RADIO HOMES	PER CENT OF TOTAL HOMES
ALABAMA	299,280	45.70	NEBRASKA	309,488	89.39
ARIZONA	73,067	70.23	NEW HAMPSHIRE	115,652	85.94
ARKANSAS	217,268	44.45	NEVADA	27,013	88.80
CALIFORNIA	1,718,707	93.28	NEW JERSEY	1,041,100	96.36
COLORADO	239,656	83.68	NEW MEXICO	56,028	56.02
CONNECTICUT	431,752	99.94	NEW YORK	3,309,987	98.89
DELAWARE	54,636	81.01	NORTH CAROLINA	396,488	55.06
DISTRICT OF COLUMBIA	150,411	88.76	NORTH DAKOTA	116,580	76.28
FLORIDA	271,324	61.90	OHIO	1,620,404	92.17
GEORGIA	388,020	55.09	OKLAHOMA	388,600	63.59
IDAHO	87,928	71.51	OREGON	251,024	83.83
ILLINOIS	1,942,188	94.66	PENNSYLVANIA	2,248,544	93.46
INDIANA	715,488	77.64	RHODE ISLAND	164,583	97.88
IOWA	583,596	87.35	SOUTH CAROLINA	202,536	50.76
KANSAS	403,680	81.86	SOUTH DAKOTA	124,120	76.05
KENTUCKY	364,008	52.73	TENNESSEE	381,524	56.57
LOUISIANA	301,600	60.26	TEXAS	1,000,036	67.24
MAINE	189,776	87.12	UTAH	98,600	81.50
MARYLAND	371,200	90.86	VERMONT	83,984	86.17
MASSACHUSETTS	1,056,968	96.24	VIRGINIA	390,804	64.70
MICHIGAN	1,086,456	90.20	WASHINGTON	402,404	84.94
MINNESOTA	621,296	93.18	WEST VIRGINIA	278,400	67.92
MISSISSIPPI	193,024	40.26	WISCONSIN	668,856	92.35
MISSOURI	821,860	77.46	WYOMING	52,481	84.64
MONTANA	106,372	74.79			

ENTIRE UNITED STATES 26,428,797 81.99%



PIONEER OF THE AIR

FOUNDED IN 1919, the Radio Corporation of America has completed 18 years of pioneering effort to develop and improve the uses of radio.

Starting "from scratch," RCA has created a world-wide communications system with direct circuits between the United States and 42 foreign countries, and with ships at sea. It has created a nation-wide broadcasting system of endless cultural possibilities, now rapidly expanding its services by short-wave to all the world. It has created essential instruments for the radio transmission and reception of sound, of code messages, and of facsimile reproductions, and for the recording and reproduction of sound on records and on

motion picture film. It has created countless radio devices indispensable to modern science, industry, medicine, telephony, and public safety. It has created the basis for a system of electronic television, forecasting the day when radio sight, added to sound, will perform a useful public service.

Today the Radio Corporation of America is owned by nearly a quarter of a million stockholders in 48 states. No one person owns as much as $\frac{1}{2}$ of 1% of its stock. Achievements of the past 18 years are a tribute to the American tradition of service in the public interest through private initiative and ownership.

RCA presents the "Magic Key" every Sunday, 2 to 3 P. M., E. S. T., on NBC Blue Network.



RADIO CORPORATION OF AMERICA

RADIO CITY • NEW YORK, U. S. A.

NATIONAL BROADCASTING COMPANY

RCA MANUFACTURING COMPANY, INC.

RCA COMMUNICATIONS, INC. • RCA INSTITUTES, INC. • RADIOMARINE CORP. OF AMERICA

Do Your Best

NOTHING, perhaps, causes the average radio dealer more headaches than the discovery that his erstwhile successful radio salesmen, more often than otherwise, turn out to be dismal flops when they turn their attention to electric refrigeration. Nor is this very surprising. There is a fundamental difference of approach required for the two devices; a complete re-orientation of the salesman's mental processes.

In this one article, therefore, we are going to attempt to provide the radio salesman with a virtual university course in refrigerator selling fundamentals. Figures quoted here are authenticated and are derived from a number of important surveys that have been made by responsible organizations in the retail appliance selling field.

The Mental Approach

A totally different mental approach is necessary where electric refrigeration is concerned. In a radio set, the fundamental use value or owner benefit that is being sold is entertainment. Once that idea has been implanted in the mind of the prospect, all the other selling approaches follow as a matter of course—superiority of the product over its competitors; its beauty or eye-appeal; its comparative inexpensiveness, etc. But the radio salesman's first job is to sell entertainment.

With electric refrigeration or washing machines, however, the fundamental use value or owner benefit to be sold is health, economy and convenience or labor-saving. The next important thing to remember in con-

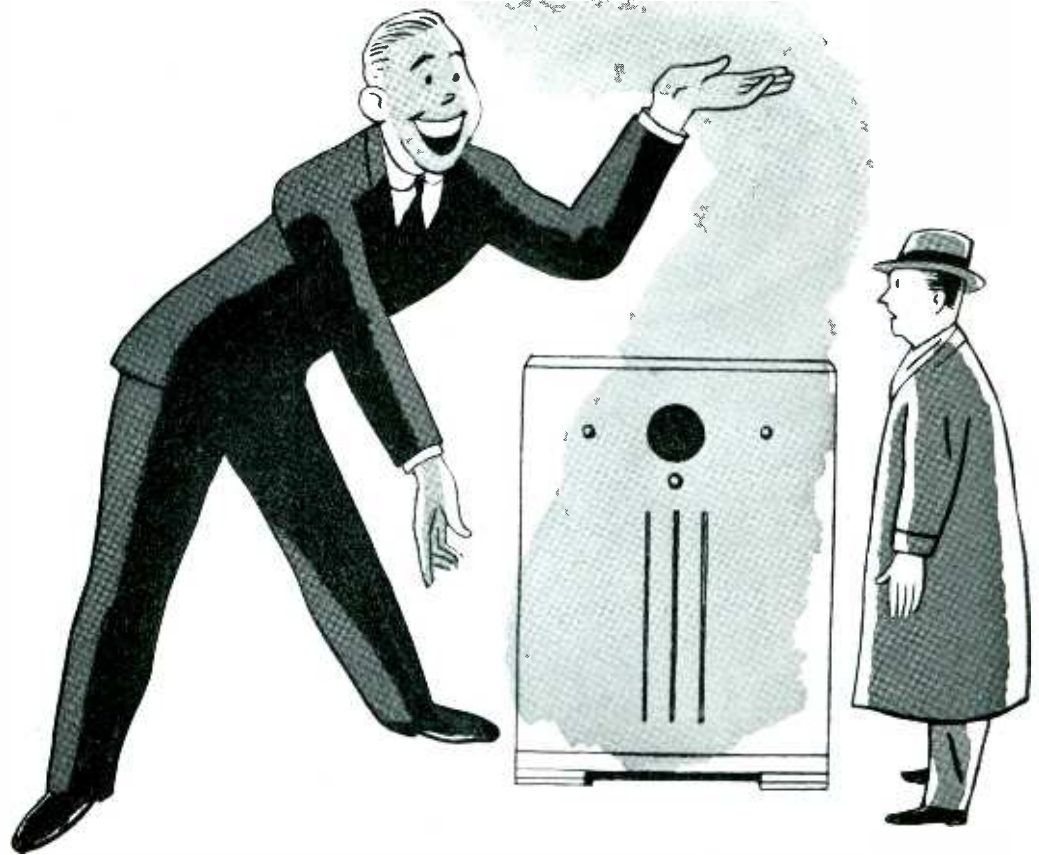

RADIO Salesmen

nection with these appliances is that *they create use-savings* which makes them almost unique in the retail selling field. Among veteran refrigerator merchandisers this use-savings story stands at the head of the list in the selling process. Prove to a woman that the purchase of a refrigerator entails no increase in the household budget, that it can be bought out of the savings it creates while in the home, you have a powerful selling tool.

To understand just how important this *use-savings* approach is, let us look at some figures:

Four out of every five families—86.1 per cent, in fact, have incomes of \$2,000 or less. A Time magazine survey of about two years ago showed that each 1,000 families in the \$2,000 income class had bought 55 refrigerators in a 2½ year period; 1,000 families in the \$5,000 class had bought 323 refrigerators in the same

period. In other words, there is 16 times the chance that your prospect will be in the \$2,000 class.

An average family in this \$2,000 class budgets its expenditures about as follows:

Food	32.2
Housing	15.8
Transportation	15.8
Savings	4.8
Personal	8.8
Clothing	10.8
Recreation	3.2
Health	2.5
Social	2.1
Taxes	0.9
Education	1.7
Civil	1.4

From the above table we find that the average family in this income classification has only \$96 a year to spend or invest in anything for the home. And it is that figure that a number of important industries in the country are fighting to get a share of. It is not difficult to see

An entirely different approach is needed when selling a utility appliance. Here's a short selling course for the man who has heretofore built his story around entertainment.

that selling that family a refrigerator which would cut their food expenditures by about 20 per cent would be a far easier thing than attempting to sell them some item which would cut into the small amount left over from regular living expenses.

That's the case in a nutshell for the emphasis that smart salesmen place upon use savings.

And now, for the skeptical, let's see just how these use-savings are brought about. First, of course, it is necessary to sell the prospect on the year-round value of electric refrigeration. Briefly this can be done in a number of ways: proving the bad effects of food spoilage and consequent risk to the family's health where insufficient refrigeration is the rule; by consulting local weather reports to find the numbers of days the temperature is within the critical range; by quoting health department reports on increased illness in the winter months; and by exhibiting testimony from local users to prove

have shown that a saving of between \$3 to \$5 a month results when electric refrigeration is employed.

The third item in the *use-savings* story concerns left-overs. A certain amount of food is discarded at each meal—food that might have been conserved if the family owned an electric refrigerator. Savings on left-overs have been estimated at from \$1.80 to \$4.50 a month.

The fourth item is the saving realized from quantity marketing. If too small a refrigerator is bought, of course, this saving would not be present and here again, the smart salesman has an additional point to make when he is selling the family a refrigerator or adequate capacity to take care of the family's needs. A minimum of 2 cubic feet of storage space for each member of the family is about right. With this capacity, the housewife can take advantage of Saturday specials and buy food in quantities, thus effecting a savings that has been variously estimated at

from \$3 to \$6.75 a month. The latter figure is the one used by the Cleveland Electrical League.

Add together these items of operating cost, food spoilage, left-overs and quantity buying and a monthly saving of from \$8.50 to \$12 a month is apparent. On \$10 monthly payments, the careful housewife would actually be saving more than she is paying out. And, at least, it can be proved that the expenditure works no hardship on the family budget.

In no other field can this use-savings story be told. It should be number one selling point when the radio salesman turns to refrigeration.

Let's jump now to the next step in the selling process—finding the prospect. Out of 173 salesmen interviewed recently only 58 were able to describe the methods they used to find prospects. That is a situation that ought to be remedied. Briefly, salesmen make five principle mistakes when they go out to look for business:

(Please turn to page 60)

"FLOP" On REFRIGERATION?

By Laurence Wray

the protective value of electric refrigeration during the winter months. So far, justifying the sale to the prospect is pretty confined to generalities which will be found readily acceptable.

The next natural is to compare cost of ice by the month with the cost of electric refrigeration. The average cost of ice per day compared to the average cost of electric refrigeration is 16.17 cents to 4.23 cents. A saving of between \$2 and \$3.50 per month can thus be proved, the amount depending on the cost of ice in the particular locality.

The second point concerns food spoilage. Competent authorities have proved that 20 per cent of the average food bill is wasted through spoilage. Using the table left on average food expenditures for the \$2,000-a-year family, we find that 32.2 per cent, or \$644 a year, went for food. Of this amount, 20 per cent, or \$128.80, is being wasted. Again you



**IT'S
A WOW!**

RCA Victor
**ELECTRIC
TUNING**
\$89⁹⁵



Here's a brand-new instrument, with radio's greatest selling feature, at a price so low you'll work overtime keeping up with sales!

IN ORDER TO SEND MORE PROSPECTS FOR THIS SENSATIONAL NEW RADIO INTO YOUR STORE, RCA VICTOR WILL

- 1 Feature Model 87K1 with strong selling commercials on all "Magic Key" programs.
- 2 Run sales-making advertising in such consumer magazines as SATURDAY EVENING POST, LIFE and COLLIER'S.
- 3 Tell the public the amazing news about the 87K1 with commercial announcements on 81 stations immediately following Metropolitan Opera broadcasts.
- 4 Smash home the story in a carefully planned newspaper campaign.

Hurry and place your order—the demand for this new model is going to be terrific! Put it right out where people can see it—and watch your cash register fill up with *profits!*

RCA presents the "Magic Key" every Sunday, 2 to 3 p. m., E.S.T., on NBC Blue Network



RCA Victor

RCA MANUFACTURING CO., INC., Camden, N. J. • A Service of the Radio Corporation of America

OVER 300 MILLION

RCA RADIO TUBES HAVE BEEN BOUGHT BY RADIO USERS...IN TUBES, AS IN RADIO SETS, IT PAYS TO GO RCA ALL THE WAY!

THIRD of a SERIES

Next Month: How to Bring Them In

RADIO dealers will find prospective buyers of phonograph records right among their regular radio customers. Unless a person is congenitally immune to sweet sounds there is no reason why he cannot be interested in recorded music. But what retailers want to know chiefly is: where in my community can I find record prospects among homes already equipped for radio entertainment?

An investigation of the social life of your community will unearth as much information as you can handle at the beginning. First, with regard to popular music—check all the colleges in your vicinity and list the fraternity houses associated with these institutions. The chances are that every house already has a phonograph. Students go for swing music in a big way and all their favorite orchestras can be had on discs. Make a point to interest the young people responsible for the social events; the society editor of your local newspaper can give you the names of these.

When selling a radio find out whether there are children in your customer's family. The introduction of this subject at the right time won't be amiss. If the children are very young, there are the possibilities of Kiddie records: fairy tales, nursery rhymes and songs, singing games, Bible stories and the famed "Winnie, the Pooh;" if they are in the adolescent stage, they dance and entertain, of course—and there's your cue. Don't forget to inquire if anyone in the family plays or studies a musical instrument. Are they interested in Benny Goodman or Toscanini? Cultivate your customers' musical interests. A sale of a tube or other accessory can always be made congenial by a remark about a recent broadcast—your customer's reaction may give you a clue to the possibility of interesting him in records.

In the field of classical music, you will find a number of sure-fire avenues through which to approach genuine prospects. Practically every city in the country supports concerts by visiting as well as local artists, and a large percentage have their own symphony orchestras, either professional or amateur, which give periodical con-

certs. These events are sponsored by local committees (including the most influential citizens) who have lists of music lovers who are known to patronize and enjoy these affairs. You can help advertise these events by displaying cards in your store and windows in exchange for names and information. You should have no difficulty discovering the parties most responsible for local musical activities—your society editor again, or the music supervisor of the public schools.

Music supervisors are excellent persons to call upon. They can give you a fine cross-section of the classical disc possibilities in your community. They are also prospects themselves—as records are used for music appreciation study in schools everywhere—and that gives you an excuse to contact them. Ask about their pupils, especially those from well-to-do families.

Professional musicians of moderate means are prospects; but it is more
(Please turn to page 81)

Best RECORD PROSPECTS

By
RICHARD
GILBERT

MANUFACTURERS OF PHONOGRAPH RECORDS

FIRM	LABELS
RCA Victor Division RCA Manufacturing Co., Inc. Camden, N. J.	VICTOR [®] BLUEBIRD [®] American agents for all "HIS MASTER'S VOICE" [®] records made by European branches of The Gramophone Co., Ltd.
Decca Records, Inc. 50 West 57th Street New York, N. Y.	DECCA [®] American agents for all British DECCA and European ODEON and PARLOPHONE records.
American Record Corp. 1774 Broadway New York, N. Y.	BRUNSWICK [®] PERFECT [®] COLUMBIA [®] MELOTONE [®] VOCALION [®] American agents for all European COLUMBIA, PATHÉ and POLYDOR Records.
Muscraff Records, Inc. 10 West 47th Street New York, N. Y.	MUSCRAFT [®]
Ganutt Records, Inc. 1107 Broadway New York, N. Y.	GANUTT [®]
Timely Records, Inc. 1600 Broadway New York, N. Y.	TIMELY [®]
The Gramophone Shop, Inc. 18 East 48th Street New York, N. Y.	"VARIETIES" [®] American agents for "L'ANTHOLOGIE SONORE" [®] (Paris) [®] "LA BOITE A MUSIQUE" [®] (Paris) [®]
Europe Importing Corp. 207 East 84th Street New York, N. Y.	American agents for TELEFUNKEN (Germany) [®]

[®]"Popular" only [®]"Classical" only
[®]Both "Popular" and "Classical"

GANGWAY! _ FOR THE

-it's that sensational

QUICK DIGEST OF NEWS ABOUT THE PRODUCT

NEW, sealed, silent POLAR POWER Unit that brings Kelvinator operating costs down to a new record low.

NEW, increased cold-making capacity, providing reserve refrigeration, if needed, equal to 1,050 pounds—*more than half a ton*—of ice a week.

NEW, freezing speed and economy—makes 72 big ice cubes for 1¢ (figured at national average rate for electric current).

NEW, exclusive Speedy-Cube Ice Release—a step ahead of anything else made today.

NEW, exclusive shelf arrangement that easily makes room for the hugest melons or turkeys—*actually* permits storage of more food, size for size, in Kelvinator than in other refrigerators.

NEW, stainless steel evaporator that spreads cold faster.

NEW models—15 beauties, with powerful eye appeal for women buyers.



1938 Kelvinator

CHAMPION ICE-MAKER: 1938 KELVINATOR!

READ—AND WE BELIEVE YOU'LL AGREE: THIS IS A DEVELOPMENT THAT RATES WITH THE GREATEST SINCE ELECTRICAL REFRIGERATION WAS BORN

SET YOURSELF for the big news about Kelvinator for 1938!

It's the biggest thing we've ever put before the industry. The greatest product . . . the most powerful advertising program. . .

An absolutely brand-new, revolutionary idea in LOCAL, ON-THE-SPOT advertising for *each dealer* . . . plus SALES SUPPORT and active SELLING HELP never before equalled!

Literally, the greatest co-operation between manufacturer and dealer since the electric refrigerator business was born!

Look at the Product!

When we call the new 1938 Kelvinator the Champion Ice-Maker, we mean every word of it!

Its new, sealed, super-silent Polar Power Unit is so efficient and economical, it delivers 72 big ice cubes for 1¢ (figured at the national average rate for electric current).

But that's only one among many new features Kelvinator has to offer in 1938. There's more—lots more—in the list over on the opposite page. Read it. And still more not even mentioned there that you'll have to see to appreciate.

Look at the Advertising!

In short, we've got a refrigerator here so grand that no advertising technique ever used before was good enough to show it.

So we had to invent a new one—a brand new way of glorifying a refrigerator in pictures . . . telling a whole sales story in pic-

tures . . . that will be one of the biggest wallops of the year!

And how we're going to use it! Full pages . . . full color . . . a full schedule running *continuously* in the most influential magazines in the country. Full pages in color in the Sunday sections of city newspapers—plus a big campaign in dailies—all listing dealer names!

Smashing, fighting, power-house stuff—built to make sales.

Look at the Sales Support!

Every bit of this pointed right straight to YOUR door—where you'll be prepared to meet it with the greatest sales-closing force ever put into the hands of any refrigerator dealer.

Because we've got a plan for you that will do the business!

It includes INDIVIDUALLY TAILORED

local advertising . . . over your OWN name . . . in the newspapers which YOU PICK YOURSELF.

Even more important . . . It includes a SALES-CLOSING program that's the hottest thing going, today. You never saw so many tested and approved sales-training materials . . . door openers . . . carefully planned seasonal selling campaigns! Or more generous customer financing plans.

And there's plenty more! Absolutely everything you need to go to town in 1938—in a big way!

Act Now!

See the new Kelvinators and get the full 1938 story from your nearest Kelvinator distributor. Or write, Dept. RR-1,

KELVINATOR, DIVISION OF
NASH - KELVINATOR CORPORATION
Plymouth Road . . . Detroit, Michigan

**\$8,000⁰⁰ CONTEST OPEN TO INDUSTRY
UNTIL JANUARY 30TH!**

ANYBODY CAN GET IN . . . open to everybody in the industry! Except factory or office employees of Nash-Kelvinator. President or office boy . . . distributor or dealer . . . retail or wholesale salesmen . . . friend or foe!
FIRST PRIZE, \$5,000! Seven other

prizes! Worth trying for! Easy—Just write fifty frank words.
See your nearest Kelvinator distributor. He'll give you all details; show you the line, the features . . . tell you the whole sales and advertising story. Come one, come all! Get into this now!

The Champion Ice-Maker

Preview of New



ANSLEY

When closed the new portable Dynaphone (electric phonograph) of the Ansley Radio Corp., 240 W. 23rd St., New York City, looks like an attractive piece of grey airplane luggage; uses a 3 tube amplifier and 6 in. dynamic speaker; has crystal pick-up with curved arm for improved tracking; provision of carrying records; \$44.50 for ac and \$49.50 for ac-dc operation

An idea of the really small size of the new Pee Wee set just brought out by Detrola Corp., Detrola Bldg. Detroit, Mich., can be obtained from the comparison with a french phone; comes in brightly colored plastic cabinets measuring only $4\frac{7}{8} \times 6\frac{1}{8} \times 4\frac{1}{2}$ in.; 4 metal tubes; dynamic speaker; ac-dc; \$15

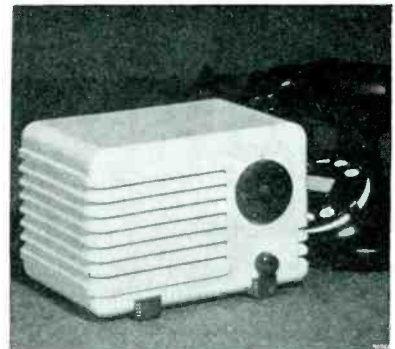

DETROLA



STROMBERG-CARLSON

Eight interim models, all equipped with the new S-C electric flash tuning, have been announced by Stromberg-Carlson Tel. Mfg. Co., Rochester, N. Y.; illustrated is Model 245-M Labyrinth radio; two sets are in the decorators' group, taking the forms of a modern desk and a drop door console

A converter unit which makes a push button tuning receiver out of any radio set, regardless of make or age and without changes in the chassis, may be obtained from the Howard Radio Co., 1731 Belmont Ave., Chicago; employs two tubes and provides 8-station tuning



HOWARD

A sick bed in the home or hospital is an ideal application for the "Hushatone" pillow speaker offered by Brush Development Co., 3311 Perkins Ave., Cleveland, Ohio; it is a crystal operated radio set accessory to be placed under a pillow

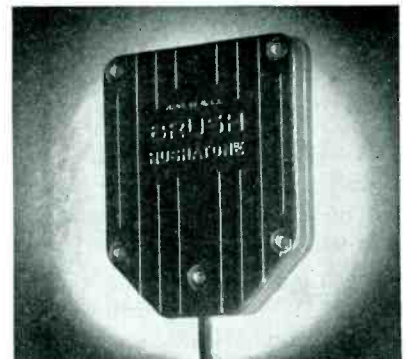

BRUSH

Radio Merchandise



SHURE BROS.

The "directivity control" switch found on the new Tri-Polar crystal microphone recently brought out by Shure Brothers, 225 W. Huron St., Chicago, permits instant selection of uni-directional, bi-directional or non-directional characteristics; knob has been designed to appear as integral part of mike case; \$39.50



ALLIED

Convenient shelves at both sides of the armchair radio of the Allied Radio Corp., 833 W. Jackson Blvd., Chicago, Ill., accommodate books and decorative pieces; 7 tubes; 16-550 meters, automatic tuning of ten favorite stations; electric eye; full vision, illuminated airplane dial; avc; double antenna connection

A line of plastic radio sets in brown, black, ivory and mandarin red is announced by Trav-Ler Radio & Television Corp., 1036 W. Van Buren St., Chicago, Ill.; 5 tube ac-dc chassis



TRAV-LEB

"Adjust-A-Volt" is a variable transformer providing smooth control of voltages to regulate ac lines, power, heat, light and motor speed; continuous control from 0-140 volts; adjustable to 4/10 volt; calibrated in 5-volt steps; Standard Electrical Products Co., St. Paul, Minn.



STANDARD ELECTRICAL

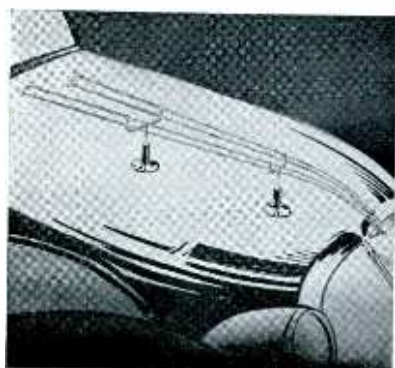

TOPSTREEM

"Topstream" is a streamlined auto aerial finished in chrome with black and chrome fittings; attaches to the car top or hood by vacuum cups; may be obtained from Topstream, Inc., 1330 Nicollet Ave., Minneapolis, Minn.

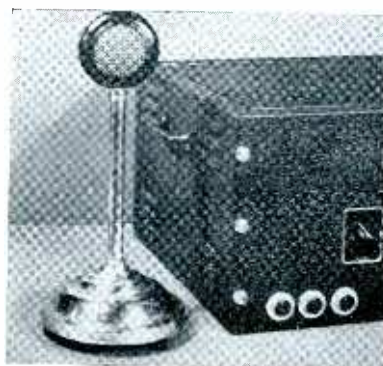

TURNER

A high level crystal microphone with an output level of minus 55 db is offered by the Turner Co., Cedar Rapids, Iowa, for \$19.50; with stand, as shown, \$22.50; makes an excellent mike for ham use but can also be used for music pickup with splendid results

The 3-time leader ... twice!

For the second consecutive year, the Columbia Network continues its leadership *in all three major phases* of network advertising:

*Columbia, in 1937, carried the greatest dollar-volume of advertising of any network in the history of radio.**

*Columbia, in 1937, was the choice of more of the country's leading advertisers than any other network.***

*Columbia, in 1937, continued as the world's largest radio network.****

This record, of course, is not Columbia's alone. It was made by the most careful buyers of advertising in the world—who increased their average expenditure for Columbia Network facilities this year over last by 25.9%.

*And did so last year.

**And has been for four consecutive years.

***And has been for five consecutive years.

In the detailed record of the CBS advertisers is the answer to every basic question you can ask about radio and radio advertising: *What do listeners think of radio? Do they enjoy it?* The answers to these questions are written by the advertisers themselves; advertisers who, in a *single* medium, find the swiftest road to any market you can name! Obviously, before these advertisers can make sales, they must make friends of America's 86 millions of listeners—make friends through radio's programs—and Columbia. Interlocked with this selling—linked as strongly as the stations to the Network—are the sales of *radio sets* in 1937. For the same programs which do the selling furnish—in their entertainment—the incentive to the listener for buying a radio. But they're only half the reason!

Throughout the year, some 22,475 Columbia programs were broadcast to the nation. More than half of these were programs '*by Columbia*'—produced by the network in the living and challenging fields of Public Affairs, Education, Serious Music, Religion, Special Events and Sports. These programs round out the schedule of the world's largest network, bringing the world's *voice*, as well as its goods, home to the nation—wherever home may be.

The C O L U M B I A B R O A D C A S T I N G S Y S T E M

PREVIEW OF NEW RADIO MERCHANDISE

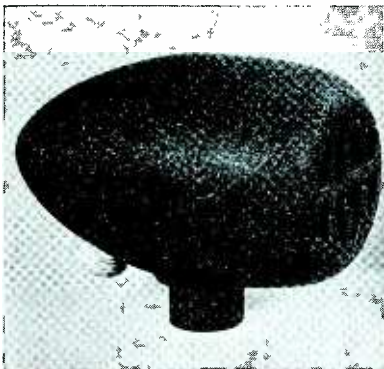

TRANSDUCER

Illustrated is Bullet Model MK-20, one of the new models for 1938 just released by Transducer Corp., 30 Rockefeller Plaza, New York City; this microphone is available in low or high impedance and is \$19.50; others range from \$27.50 to \$90

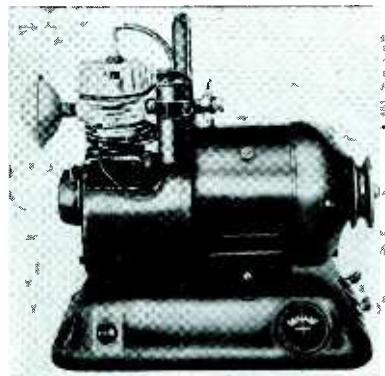

CONTINENTAL MOTORS

Four Tiny Tim battery chargers—covering all 6, 12 and 32 volt requirements from 150 to 300 watts—are offered by Continental Motors Corp., 12801 Jefferson St., Detroit, Mich.; list prices range from \$45 to \$70 at Detroit; everything for a low cost lighting plant may be obtained as a complete outfit

Two oscilloscopes, 2 and 3-inch screens, are announced by Triplett Electrical Instrument Co., Bluffton, Ohio; both incorporate the exclusive Triplett turret-tube mounting feature which permits easy adjustment of the tube up or down, or to either side, so the screen is always in direct view of the operator

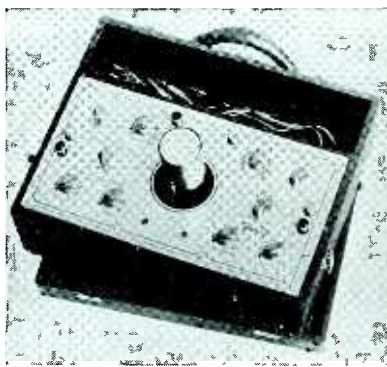

TRIPLETT

A wide range of tests is covered with the tube and set tester of the Simpson Elec. Co., 5216 W. Kinzie St., Chicago; designated as Model 440 it was designed, according to the manufacturers, to incorporate every possible test and range for general servicing, auto-radios, pa systems and transmitting equipment

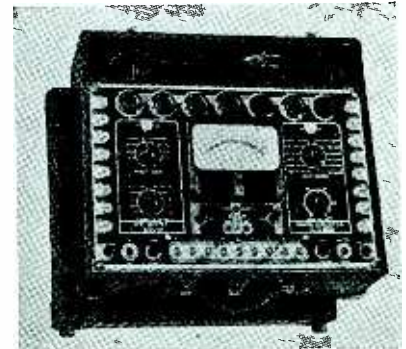

SIMPSON

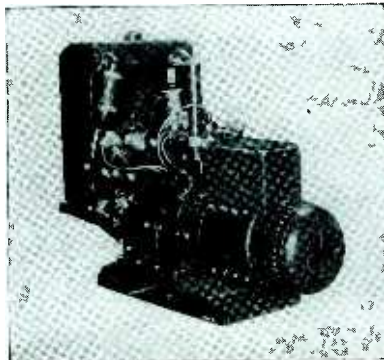

ONAN

A compact and light weight electric generating plant is offered by D. W. Onan & Sons, 43 Royalston Ave., Minneapolis, Minn.; 5000 watt ac unit; particularly well adapted for service in large homes, schools and for portable service by construction crews

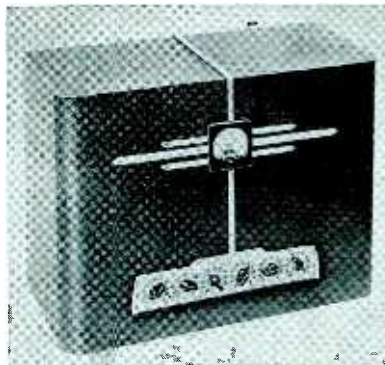

AMPLIFIER CO.

The 35 watt audio spectrum controlled beam power amplifier of the Amplifier Co. of America, 37 W. 20th St., New York City, has an overall gain of 135 db; phono, radio and microphone inputs; universal output; features flexibility of performance; dimensions, 22x10 1/2x16 in.; \$325; without audio spectrum control, \$225

An attractive streamlined chassis houses the new 32 watt dual channel amplifier made by Amplitone Products Co., 135 Liberty St., New York City; incorporates a 3-position electronic mixer with individual controls; output level indicator; cathode drive; \$37.50, less tubes



AMPLITONE

Designed in handy circular form for either bench use or panel mounting and continuously variable in a range from 0 to 1.0 megohm with a direct-reading calibrated dial, the new resistance analyzer and indicator just announced by International Resistance Co., 401 N. Broad St., Philadelphia, Pa. is ready for distribution

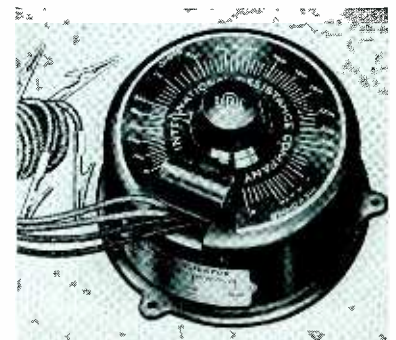

INTERNATIONAL RESISTANCE

PREVIEW OF NEW RADIO MERCHANDISE

Model P. R. telescoped acoustic reproducer made by University Laboratories, 191 Canal St., New York City, is actually a 3½ ft. exponential air column trumpet internally folded to reduce the length by more than one half; especially suited for outdoor use where high efficiency speech reproduction is necessary

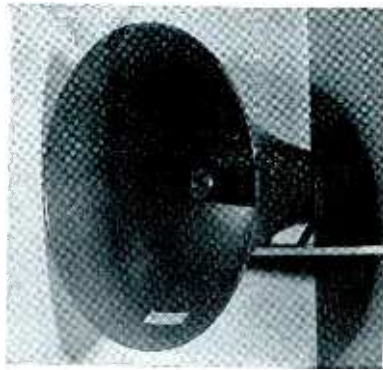

UNIVERSITY

Either 10 or 12 in. record can be played on the record changer just introduced by Garrard Sales Corp., 17 Warren St., New York City; available in any current and also with crystal pick up; "reject" and "repeat" knobs; electric current automatically switches off when last record is played

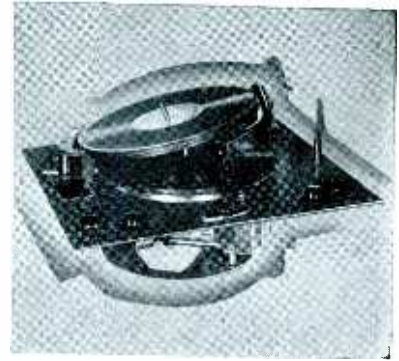

GARRARD

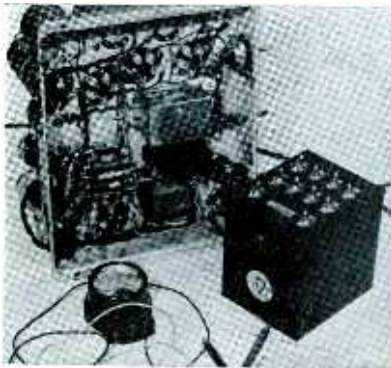

HALLDORSON

Line voltage in one-volt steps from 0 to 256 volts and one-half volt steps from 0-128 can be adjusted with the Vari-Volt transformer of the Halldorson Co., 4500 Ravenswood Ave., Chicago; has many other applications in the electrical field



BAND MASTER

Model III Amplifier made by the Bandmaster Co., 111 Dartmouth St., Boston, Mass.; consists of 15 watt chassis, ribbon (velocity) microphone, adjustable chromium floor stand, two p.m. dynamic speakers; carrying cases, cable, etc.; will serve gatherings up to 3,000 persons; dealer's net price, \$66

Radio interference can be effectively reduced with these small capacitors announced by the General Electric Co., Schenectady, N. Y.; Pyranol treated and wax sealed; the .5/.5 mu f were developed primarily for use with old burner ignition transformers .02/.002 / .002 mu f units are effective with small dc motors

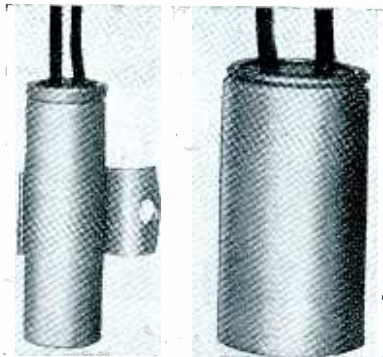

GENERAL ELECTRIC

Deep nicks and scratches in wood, plastic and Bakelite cabinets and white refrigerators can be easily filled with the shellac patch "Stiks" made by General Cement Mfg. Co., Rockford, Ill.; walnut, oak, black and white sticks, alcohol lamp, etc., included in kit at \$2.25



GENERAL CEMENT



TELETOUCH

With the "Teletouch Magic Switch" the passerby, by merely waving his hand in front of a sign, turns on a radio in the window, starts a motor or any display operated by electric current; just plug in, connect desired display and it is ready to operate; \$50; Magic Mirror Corp., 37 W. 54th St., New York

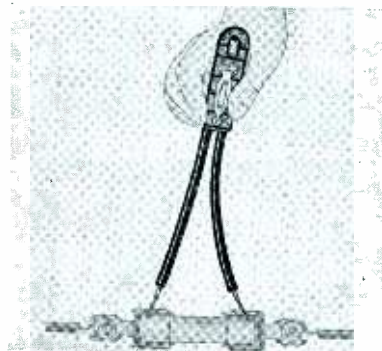

BRACH

The Test - O - Lite, widely used for many years, is now equipped with a pocket clip; another improvement is increased sensitivity so that it more easily detects the presence of voltage from 90 to 500 v. ac or dc by the small neon lamp; made by L. S. Brach Mfg. Corp., 55 Dickerson St., Newark, N. J.

"Mister



Joseph Leberer, wholesale man for the Joseph Strauss Company of Buffalo, presents the Leonard plans to T. S. Rosinski, of the Rosinski Furniture Company, Lackawanna, New York

FLASH!—"It's a hot line!"

NEW, SILENT, SEALED "GLACIER" UNIT . . . with tremendous power reserve . . . an absolute marvel on economy and operating efficiency.

SENSATIONAL "ICE POPPER" CUBE RELEASE . . . fast, sure . . . sells itself as swiftly as it snaps out cubes.

NEW STAINLESS STEEL "ZERO-FREEZER" . . . squeezes more cold (and ice) out of a minute's running-time than anything you've seen yet.

"FOOD FIT" SHELVES . . . A shelf-adjustment for each inch of food-compartment height . . . handle *anything*.

FAMOUS "MASTER DIAL" . . . still tops in exact cold control.

"LEN-A-DOR" PEDAL . . . door opens at a toe-touch . . . and that one great feature sells a tremendous number of Leonards.

THE LEONARD BUILT-IN THERMOMETER instantly gives the exact temperature of food compartment . . . easiest to see and read!

THE VEGETABLE BIN holds 1/4 bushels . . . a space and money saver. **INSIDE THE DOOR** . . . real **ARRANGING SHELF** appeals to any woman . . . because she **KNOWS** she needs it.

THE LEONARD CRISPER keeps green-groceries garden-fresh . . . and every woman knows it will save grocery-money for her.

1938 LEONARD

THIS ONE IS A NATURAL!

NO WHOLESALE MAN IN THE REFRIGERATION BUSINESS HAS EVER HAD A STORY LIKE THIS TO PRESENT TO A DEALER!



600 LIKE HER WROTE THE 1938 LEONARD STORY And no refrigerator manufacturer has ever had a selling story like this to tell!

It's spreading like a prairie fire!

It gets everyone who hears it . . . sees it . . . distributors . . . wholesale men . . . and now dealers!

Why? Because product and plans are pitched for the peak in profits . . . yet

they're simple and workable as a knife and fork on a juicy steak!

FLASH! All based on something that's never been done before by any refrigerator.

For almost a year . . . 609 women in 48 states have been testing this new 1938 Leonard on the job!

They've proved it's the most powerful, economical and usable refrigerator on the market today!

That's *selling*-power! Everything a customer wants to know about this new Leonard is answered by a mass of real EVIDENCE. *Facts*—not guesses!

FLASH! The product itself is a knockout!

You know Leonard has *always* been able to hold its own . . . in any comparison. *This 1938 Leonard will be the toughest one anybody ever tried to sell against!*

Its big features are given here, in a boiled-down list you can go through fast. That tells you . . . this new Leonard is PLENTY HOT!

FLASH! Leonard's national advertising campaign this year is designed as no other refrigerator advertising ever was before . . . for ONE PURPOSE:

TO BRING IN THAT STORE TRAFFIC . . . TO DELIVER THOSE PROSPECTS INTO YOUR HANDS, RIPENED AND READIED FOR THE SALE.

Can't give the details here . . . but it's a \$9,500 PRIZE CONTEST of an interesting kind that's *known to be a natural*.

And they've got to come to you to get in on it.

PLUS your own local advertising, keyed-up to a new pitch of "pull" and power. PLUS the keenest, surest-fire, most practical "complete bundle" of ACTUAL SALES-MAKING HELP you ever had!

FLASH! Ready for you right now! You can see the 1938 Leonard line . . . hear the whole story . . . size up the plans and judge how they'll fit into, and reinforce your own 1938 business plans.

It is a steel-riveted cinch that YOU OWE IT TO YOURSELF to know where Leonard's going in 1938.

• • •

Put it up to your Leonard distributor now, before the train pulls out. Or just let us know, here at the factory: "All right, Leonard! I want to take a look . . . quick."



HERE'S ONE YOU CAN GO TO TOWN ON! Greatest story any refrigerator distributor ever had to tell!

LEONARD, Division of Nash-Kelvinator Corporation, Detroit, Michigan

"Biggest Bargain in Refrigerators Today"

PREVIEW OF NEW RADIO MERCHANDISE

The Phonohm volume control for head sets incorporates the "L" pad attenuator circuit so that the impedance is maintained constant at the nominal impedance value of the headset regardless of volume control setting; weighs slightly over 1 oz.; Centralab, 900 E. Keefe Ave., Milwaukee, Wis.

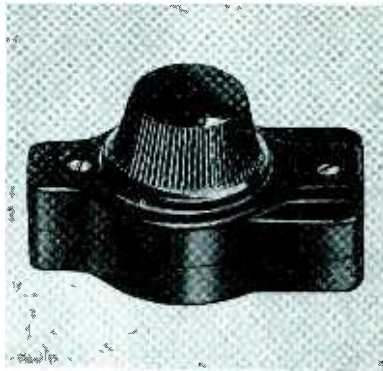

CENTRALAB

Several new exclusive features, including a variable output, have been incorporated in the two Vibrapaks just placed on the market by Electronic Laboratories, Inc., Indianapolis, Ind.; Model 31 is for operation on 6 volts dc and Model 51 is a 12 v. input unit

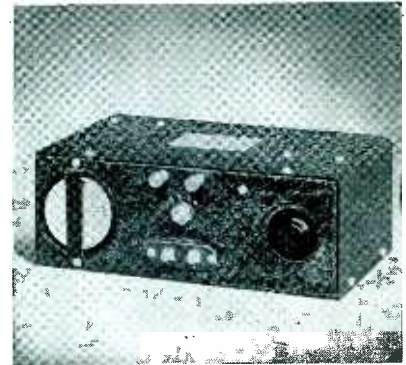

ELECTRONIC LABS

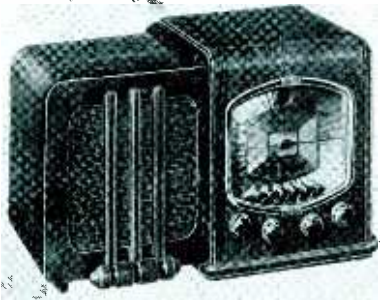

GREBE

"Presto-Matic" instantaneous tuning is available on the four new models just added to the line of Grebe Mfg. Co., 119 Fourth Ave., New York City; illustrated is 762L, 7 tubes, ac-dc, 173-555 and 16-53 meters; the ultra modern cabinet is walnut

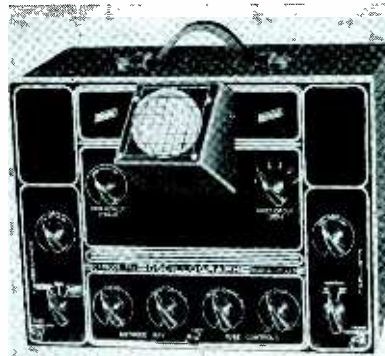

HICKOK

Model RFO-5 standard 3 in. oscillograph of the Hickok Electrical Instrument Co., Cleveland, Ohio, has a removable screen and adjustable cathode ray tube mounting; also focusing, intensity and positioning controls; locking sweep circuit; automatic synchronization; size 11 x 9 x 8 in.



PIONEER

Three new types of "Pinco" dynamotors have been announced by Pioneer Gen-E-Motor Corp., 464 W. Superior St., Chicago; Type PS is designed for output up to 45 watts with either 6 or 12 volts; CS, 300 watts intermittent or 250 watts continuous duty; TS, 525 watts intermittent or 400 watts continuous

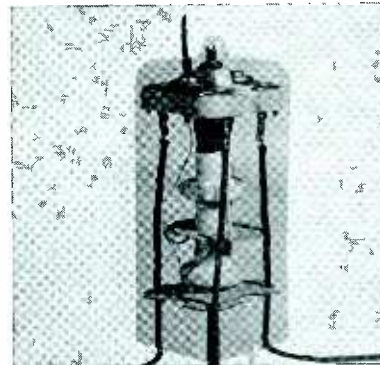

MEISSNER

A new line of standard I.F. double tuned transformers, known as the Wide Range Line, has been placed on the market by the Meissner Mfg. Co., Mt. Carmel, Ill.; with only 4 standard wide range transformers a serviceman can tune to any I.F. frequency required from 121 to 650 kc. without skip

An entirely new midsize variable control. Series 37 and 37-S (with switch), to fit assemblies where space is at a premium has been developed by the Clarostat Mfg. Co., 285 N. Sixth St., Brooklyn, N. Y.; smooth operation characterize these controls; available in linear and tapered resistance ranges from 1000 to 5 megohms

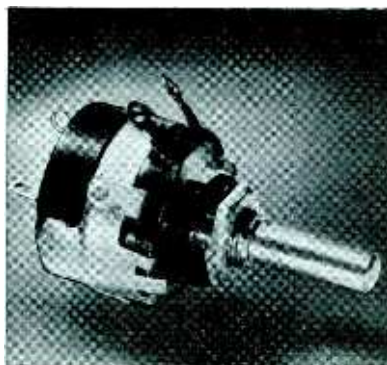

CLAROSTAT

Offering a wide choice of condenser, inductance and ground connection arrangements in the form of 6 convenient plug-in devices, Aerovox Corp., 70 Washington St., Brooklyn, N. Y. has worked out solutions for practically every kind of line noise; the type of filter to be used can be ascertained with an Aerovox noise analyzer

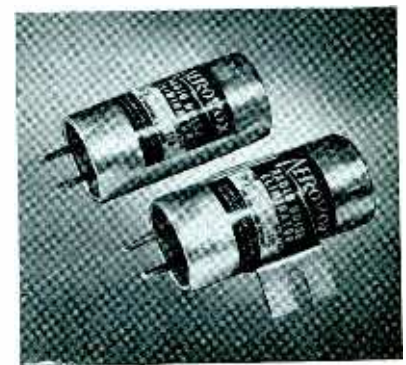

AEROVOX

ANY FAMILY ANYWHERE IS A PROSPECT FOR THE *New 1938*

Runs on gas, kerosene, or bottled gas... This different refrigerator offers famous freezing principle plus new, improved conveniences

SERVEL
ELECTROLUX
THE *Gas* REFRIGERATOR

BIG BUSINESS. Business that's growing all the time. That's what dealers from coast to coast are enjoying with Servel Electrolux. For this is the refrigerator your customers *hear* so much *about*. It's the only automatic refrigerator that has no moving parts in its freezing system. This simplicity means permanent silence . . . continued low running cost . . . freedom from costly upkeep . . . and SAVINGS THAT PAY FOR IT.

Best of all, you can sell this different refrigerator—no matter where your prospect is located. For Servel Electrolux runs on gas, kerosene, or bottled gas. There's money ahead for dealers in 1938, so write today for full information about available franchises. Servel, Inc., Servel Electrolux Sales Division, Evansville, Indiana.

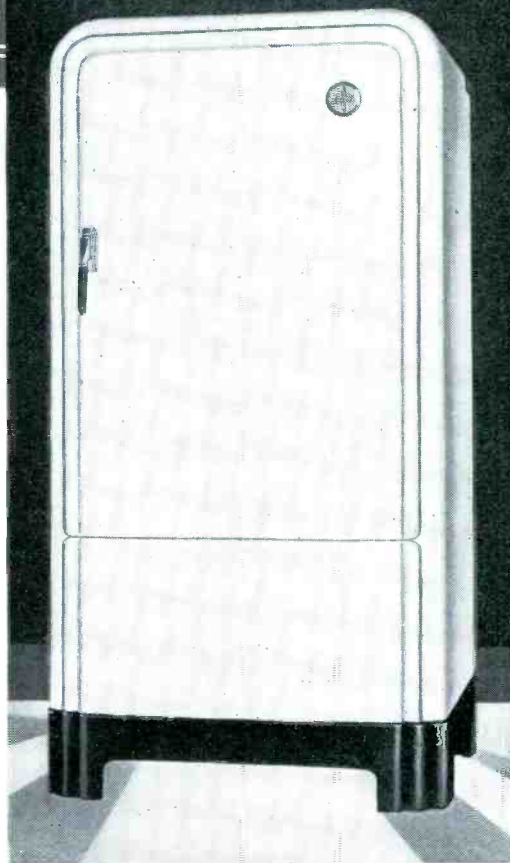

- PERMANENTLY SILENT
- NO MOVING PARTS TO WEAR
- CONTINUED LOW OPERATING COST
- NEW, MODERN CONVENIENCES

Sell the Refrigerator **THEY HEAR ABOUT
BUT NEVER HEAR**

PREVUE OF NEW RADIO MERCHANDISE

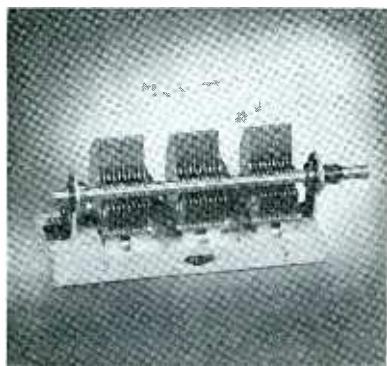

BUD

A three gang midget condenser can be obtained from Bud Radio, Inc., 1923 E. 55th St., Cleveland, Ohio; mounted on a ceramic base, 1 3/4 x 5/4 in.; supplied in several capacity sizes; rotor and stator plates are made of brass and securely soldered to their respective shafts



PENNWOOD

Designed in the modern manner of attractive woods, metals, leathers, mirrors and plastics, to fit any decorative theme, the "numeral" clocks of the Pennwood Co., 7525 Kensington St., Pittsburgh, Pa., tell time without use of the usual clock hands; to the left is the Chieftan in black or walnut;

\$4.95

The "Pluggin" condenser of the Tobe Deutschmann Corp., Canton, Mass., is installed in an ordinary tube socket, making possible split-second replacements; has UX 4-prong tube base; rated at 475 volts continuous operation, 600 volts peak; \$1.60, \$1.75 and \$2.65



TOBE DEUTSCHMANN

Another popular Pennwood model is the Imperial, \$7.95; these clocks are electric and self starting; movement consists of only four molded drums and a supporting chassis; use of Saporill, newly developed lubricant, prevents gumming; four models with pen and pencil for home or office desk use are also available



PENNWOOD

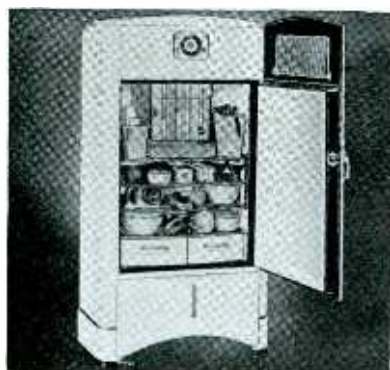

LEONARD

Basic improvements that mean increased economy and improved performance are incorporated in the new line of the Leonard Division, Nash-Kelvinator Corp., Detroit, Mich.; 11 models; heading the list of features is the "Glacier Unit;" an "Ice Popper," "Food Fit" shelves, "Zero Freezer" evaporator are among the highlights.



DICTOGRAPH

A combination microphone-loudspeaker for installation outside the front door and a table or wall-type hand set phone conveniently located inside the house for communication with visitor ringing bell before admitting to the house may be obtained from Dictograph Products, Inc., 580 Fifth Ave., New York

Foremost among the new features of the 1938 line of refrigerators just announced by the Kelvinator Div., Nash-Kelvinator Corp., Detroit, Mich., is the sealed Polar Power Unit, which has greater efficiency and capacity; convenience is the keynote of improvements introduced into the cabinet interior; Super Deluxe models are air conditioned



KELVINATOR

Designed to cook fast, cook better and save money, the new 1938 line of Westinghouse Kitchen Proved ranges incorporates attractive styling and mechanical improvements; 10 models; new SuperOven has increased capacity and scientifically balanced heat distribution; Westinghouse Elec. & Mfg. Co., Mansfield, Ohio



WESTINGHOUSE



MEANS PROFIT TO YOU!

...because it means

PUBLIC ACCEPTANCE!



YOU'LL get further proof of RCA Radio Tubes' public acceptance by making this simple test yourself. Just put RCA Radio Tubes alongside any others and let your customers make their own selection. Nine times out of ten RCA Radio Tubes will show you the value of name and reputation!

The public acceptance of RCA Radio Tubes results from 15 years of consistent consumer advertising, plus excellent performance in the homes of millions of Americans. And public acceptance is one reason why the name "RCA" means profits to you!

SURVEY PROVES ACCEPTANCE OF TUBES MARKED "RCA"

In a recent survey of the people who asked for radio tubes by brand name:

77% asked for RCA. 10% asked for Brand "A"
2.6% asked for Brand "B". 2.6% asked for Brand "C"
7.8% asked for all other brands

Over three hundred million RCA radio tubes have been purchased by radio users...
in tubes, as in radio sets, it pays to go RCA All the Way

RCA presents the "Magic Key" every Sunday, 2 to 3 p. m., E. S. T., on the NBC Blue Network



Radio Tubes

RCA MANUFACTURING CO., INC., CAMDEN, N. J. • A SERVICE OF THE RADIO CORPORATION OF AMERICA

The
TRIUMPHANT
1938
GIBSON

Easiest To Sell In Volume
Because It Gives



MORE!

MORE ICE CUBES . . . MORE FOOD CAPACITY . . . MORE preservation of natural food flavors . . . MORE hot weather dependability . . . MORE every-day convenience . . . MORE beautiful design . . . MORE of everything your customers want . . . and urged ahead by a National Advertising and Sales Promotion Plan that gives MORE of everything YOU want!

Inquire! Get set now for YOUR biggest year in Gibson's biggest year—1938! GIBSON ELECTRIC REFRIGERATOR CORPORATION, Greenville, Michigan. CHICAGO: American Furniture Mart. Export Sales Department: 201 North Wells St., Chicago, U. S. A. Cable Address: Gibselco, Bentley Code.

GIBSON

THE FREEZ'R SHELF REFRIGERATOR

NEWS

Parts Show Plans Well Along

Booth contracts mailed Jan. 1.
Many space reservations already in

CHICAGO—Exhibition Hall at the Stevens Hotel will be known as Radio Parts City during the June 8-11 offering of the National Trade Show, Inc. Each "street," "avenue" and "boulevard" will be named in honor of a deceased outstanding figure in the development of radio.

The eastern and western divisions of the Sales Managers Club will meet jointly with the Show Corporation at 10 a.m., Thursday, June 9. Technical lectures for servicemen will be arranged by the Chicago Chapter of the RSA in collaboration with the national office of this servicemen's association.

The Chicago Council of Amateur Clubs will supervise amateur activities. The Chicago Section of IRE is reported planning a meeting during the show period. The "Representatives" and the National Association of Radio Parts Distributors will hold their regular meetings also.



OK PARTS SHOW PLANS—Approving the layout for the 1938 National Parts Show are these directors of the group sponsoring it. Left to right, *Arthur Berard, Arthur Moss, K. C. Prince, H. E. Osmun and S. N. Shure. Ken Hathaway, managing director, wields the explanatory pencil*



RADIOFONE HEAD—Concentrating his fire on wireless intercommunicators is *Joseph S. Klein*, sales and franchise director of the Radiofone Corporation of New York

New Kadettes Shown

Five quality models at moderate price exhibited by Jackson

CHICAGO—On exhibition at the Hotel Blackstone as this issue closed were five new Kadette radio models. W. Keene Jackson, general sales manager for the International Radio Corporation of Ann Arbor, Michigan, had them under his wing, pointed out that they were in the quality class and yet were moderately priced. Features to which particular attention was called included cabinet inlays of cork, die-cast escutcheons and an unusual new dial called "Thermodial", which resembles a thermometer.

Assisting Mr. Jackson at the Blackstone were Messrs. Al Rapfogel of Cleveland, Jimmy Woods of New Orleans, Jack Hursch of Denver, Glenn Kuffer of Chicago and Gere Burns.

In South America at the time of the exhibit was Kadette president C. A. Ver-

schoor, vacationing with Mrs. Verschoor. In the east, aiding jobbers to clear the stage for a presentation of new models, was vice president and general manager John Bradfield.



TRAVELING—*John Bradfield*, International Radio Corporation's genial general manager



HUNTERS AND A HANDCAR—In the Canadian wilds: *Ross C. Siragusa, Kenneth Turner, Harry Clippinger and John Huarisa, all of Continental Radio & Television Corporation.* Ed. Note: What is this, "Field and Stream"?

Click, No Bang

Three Continentals tell tale out of school about Clippinger hunting prowess

CHICAGO—It seems that Messrs. Siragusa, Turner, Huarisa and Clippinger, execs of Continental Radio, have just returned from a 10-day hunting expedition 150 miles north of Port Arthur, Canada, in the vicinity of Sioux Lookout. With them comes two 1200-lb. moose . . . and a story.

Clippinger, another member of the party and a guide walked three hours through eighteen inches of snow trying to find something to shoot at. Nothing even wiggled, until, finally, two moose were spotted, peacefully reclining on a hillside about 200 yards away. Clip, fascinated, brought up his gun, pulled the trigger. Result: A mild click, no bang. Feverishly, he worked at the gun, pulled the trigger again. Result: Another click. The shell had frozen, jammed.

Meanwhile, Clip's companion was banging away with everything but a bean-shooter. Clip finally freed the gun, joined him. Eventually, the moose apparently grew tired of the din, got up and walked away. Much to the party's surprise, examination of the ground indicated a hit. And so it was. For in three hours of tracking they finally caught up with a wounded animal, put it out of its misery.

Interviewed shortly after his return from Canada, Mr. Clippinger informed *Radio Retailing's* reporter that Continental was about to place on the market a new line of Admiral radios bringing automatic tuning to consumers of limited means. New, low-priced table models are to have 6-station Touch-O-Matic electric motor tuning and automatic volume control, are to tune in the American broadcast band and also get 19, 25, 31 and 49 meter foreign broadcasts as well as police-calls, amateurs, aviation and ships at sea. For the farm market, simultaneously, a line of receivers operating on either storage battery or alternating current have been developed.

New Dumont Plant

UPPER MONTCLAIR, N. J.—The Allen B. DuMont Labs., Inc., moved shortly after the first of the year to a new and larger plant at 2 Main Ave., Passaic. Personnel is to be doubled.

Six Utahrians Upped

Beasley advances Jester, Barrett, Dumke, Ellmore, Neyman and Burress

CHICAGO—From G. Hamilton Beasley, president of Utah Radio Products Company, comes word that the board of directors have confirmed the following new appointments and promotions:

Oden F. Jester, for many years general sales manager of Stewart-Warner's radio division and recently resigned as vice-president in charge of sales for Motor Master Products, assumes the post of general sales manager.

E. L. Barrett is now vice-president in charge of development and research engineering.

William F. Dumke has been elected vice-president in charge of production and plant supervision.

Austin W. Ellmore becomes chief engineer.

H. S. Neyman has been placed in charge of the general office, continues also as secretary and treasurer.

John Burress has been placed in charge of purchases.

B. J. Clarke has tendered his resignation as vice-president, continues as a member of the Board.

Benny Cops Pilot Award

Called 1937's outstanding and consistent radio performer at Waldorf luncheon

NEW YORK — At the anniversary luncheon of the Pilot Radio Award So-

ciety, held in the Waldorf-Astoria Hotel December 15, Jack Benny was awarded a silver cup, the organization's first annual award of merit, for "outstanding and consistent radio performance during 1937."

Sylvester T. Thompson, chairman, headed the committee making the award. Bide Dudley acted as master of ceremonies. Alvin Austin accepted the cup in Mr. Benny's absence.



UTAHRIANS—*Oden F. Jester, Utah's new general sales manager. E. L. Barrett, now vice-president in charge of development and research. William F. Dumke, vice-president in charge of production and plant supervision*

LEONARD'S SHOW



OPENING GUN—It was fired by vice-president *H. W. Burritt*, who told about new Leonard refrigerators



ARRIVING—*G. W. Henzel* and *Frank May* of the *E. S. & E. Company*, Albany, *George B. Gray* of Miami's Major Appliances, Inc. and *B. T. Poe*, Leonard district manager



ONCE-OVER—The new unit gets the eagle-eye from *R. A. Tulp* and *V. E. Allen* of Graybar Electric, Los Angeles

More Brunswick Offices

NEW YORK—Due to an increase in business during 1937 the Brunswick Record Corporation has found it advisable to open branches in Detroit, and in Boston. These are opening for business as this issue mails.

RADIO RETAILING, JANUARY, 1938

American Radio Association Formed

New group for service engineers plans attack on industry evils

CHICAGO—Eight radio service engineers met here December 1, formed the American Radio Association, labelled this new organization: "A National Association of Radio Service Engineers." Tom Hogan was elected president, Felix Sutken, vice-president, and Marcus Hinson, Secretary. Mr. Hinson will be remembered for his former affiliation with the Institute of Radio Service Men.

Planned is a membership drive, spotlighting of alleged industry evils, including:

1. Unfair competition of many wholesalers.
2. Unfair competition of many manufacturers.
3. Unfair competition of many radio amateurs.
4. Disparagement of the character and ability of radio service engineers by other branches of the industry.
5. Disregard of Fair Trade Practice laws.
6. Deliberate destruction of service associations.
7. Excessive price of parts.
8. Excessive price of tubes.
9. Excessive prices for equipment.
10. Low prices charged for service.
11. An unsound price structure.
12. An unsatisfactory system for training radio service engineers.
13. Poor distribution of genuine parts.
14. The marketing of too many models of radio receivers.

National headquarters has been established at 500 North Dearborn Street, Chicago.

GE Ups Wilson

SCHENECTADY—Charles E. Wilson of Bridgeport, Connecticut, vice-president in charge of General Electric's appliance and merchandise department since 1930, has been elected executive vice-president of the company, a new position.

Murray Resigns As Bosch President

SPRINGFIELD — Arthur T. Murray, chairman of the RMA's set division, has resigned the presidency of the United American Bosch Corporation. He continues as a director of this company and as a member of its executive committee but joins the Moore Drop Forging Company, this city, shortly after the first of the year.

Jensen In Canada

CHICAGO — To facilitate service to Canadian radio set manufacturers, Jensen Radio Manufacturing Company has concluded arrangements with Canada Wire

and Cable Company of Toronto for the manufacture of Jensen-engineered products. Canada Wire and Cable will make and ship Jensen speakers, under the supervision of K. M. Cliphsham. A sales office, C. A. Savage in charge, is to be located at 45 Richmond Street, West, Toronto.

Stahl Now Heads Arcturus

NEWARK — Charles E. Stahl, former vice-president and general manager of the Arcturus Radio Tube Company, has been elected president, retaining, at the same time the general managership. J. A. Stobbe has been elected a vice-president. And Jack Geartner becomes sales manager in charge of all sales, including export.

Fair Trade Rules Still "Hang Fire"

RMA and FTC outlines agree on most major points but do not see eye to eye regarding details and verbiage

WASHINGTON — The proposed fair trade practice rules for receiving set manufacturers are again under indefinite advisement by the Federal Trade Commission following a public hearing at the Commission's headquarters in Washington on December 7. A large number of manufacturers and other interests participated.

Although the RMA formally "disapproved" the rules proposed last month by the Commission, a revised draft, previously presented by RMA on February 9, plus additional rules to prohibit "spiffs," P.M.'s, and "dummy" tubes was presented by James M. Skinner of Philadelphia, chairman of the Association's trade practice rules committee. He stated that the fair trade merchandising principles of the Commission and the proposed RMA rules were not at variance, but that the questions involved were ones of detail and verbiage.

Special objection to the Commission's proposed rule regarding "origin and manufacture" of receiving sets to be identified was made in the RMA statement by Mr. Skinner. General merchandising practice in sale of many special brand products does not require labels of the manufacturers, Mr. Skinner pointed out, and manufacturers' names in such distribution convey no useful information to the purchaser.

Another general objection to the Commission's rules, voiced for RMA by Mr. Skinner, was against the requirement for details, in kilocycles, in advertising "all wave" sets.

Other RMA criticism of the Commission's rules was against the complex, vague and detailed advertising code proposed which, Mr. Skinner pointed out, would seriously restrict national advertising of radio.

That the RMA recommendations were not a unanimous report was stated by E. F. McDonald, Jr. of Chicago, a member of the RMA committee, who told that

he felt the word "origin" should be included in the proposed rules, to require set manufacturers to identify their merchandise.

Opposition to the proposed Commission requirement for identifying "origin and manufacture" of sets was detailed by A. S. Wells of Chicago, another director and committee member of RMA. No other industry rules and no law or court decision, Mr. Wells stated, require such identification of special brands.

Also opposing the Commission's proposed identification of "origin and manufacture" of sets was W. C. Fox, counsel of the National Retail Drygoods Association, who stated: "There is no deception of the public. The proposed rule would upset established national channels and methods of distribution."

Support for the proposed rule on special brand merchandise was given by William H. Ingersoll, representing the Electrical Appliance Dealers Association of New York.

Representing the Washington and also the National Better Business Bureaus, Miss Muchmore of Washington also urged a rule on misleading advertising on trade-in allowances, declaring them a public deception.

The Commission was urged by O. Fred Rost of New York, editor of *Radio Retailing*, to accept the RMA rules, which he pronounced an important step by the industry, pointing out that there were very few fundamental differences between the Commission and the RMA proposals. He said certain Commission rules would increase manufacturers' expenses, change advertising and selling methods, and result in increased cost of radio to the public.

The Commission hearing was conducted by chairman George McCorkle and assistant chairman Henry Miller of the Commission's Trade Practice Conference Section. At the close, they announced that the various rules proposed would be considered further by the Commission, with no indication of when a final decision may come.

Western Mart January 24-29

Two whole floors devoted to radio and appliances at Pacific Coast exhibit

SAN FRANCISCO—Five great home furnishing markets will unite in the Western Furniture Exchange and Merchandise Mart during the western winter market, January 24 to 29.

The fourth and fifth floors of the mart will house radio, gas and electric appliance exhibits and manufacturers are scheduled to introduce important new models. On Wednesday evening, January 26, the seventh consecutive semi-annual Radio and Appliance Trade Dinner will be held in the main dining room of the Mart Club.

Entertainment is planned for visiting members of the trade.

More Room For Atlas

BROOKLYN—Atlas Sound has taken another floor at 1451 39th Street, is utilizing this additional space to take care of increased production demands.

AT KELVINATOR CONVENTION



TOPS—George W. Mason, right, president of Nash-Kelvinator Corporation, and Charles W. Nash, chairman of the board



SALES AND ENGINEERING—Marvin S. Bandoli, left, sales manager of household refrigeration, and Edward Heitman, chief engineer



IN THE MIDDLE—R. C. Cameron, sales manager of household appliances, dines between C. F. Gaylord of Pittsburgh's Rogers Company, left, and J. W. Rondel of this same distributing outfit

BIRDSEYE AT GIBSON'S



BLUE VASE—Gibson's general sales manager, F. E. Basler, explains the Blue Vase Contest for distributor's salesmen to president Charles J. Gibson



BANG!—Sales promotion manager J. L. Stephens actually fired this shot gun during his talk, apparently using it for punctuation



ON HIS FEET—Vice president L. W. Hamper, addressing Gibson's Freezer Shelf convention, told all about new factory additions and advances in production methods

RCA—Hazeltine Bury Hatchet

NEW YORK—The Radio Corporation of America has entered into agreements with Hazeltine Corporation whereby it has acquired simple non-exclusive licenses in all radio fields under the Hazeltine patents. These agreements affect termination of long pending litigation between the parties.

NORGE

DEALERS ARE ALREADY BREAKING "Profit Quotas"
WITH *Products* DESIGNED TO MEET PUBLIC DEMAND

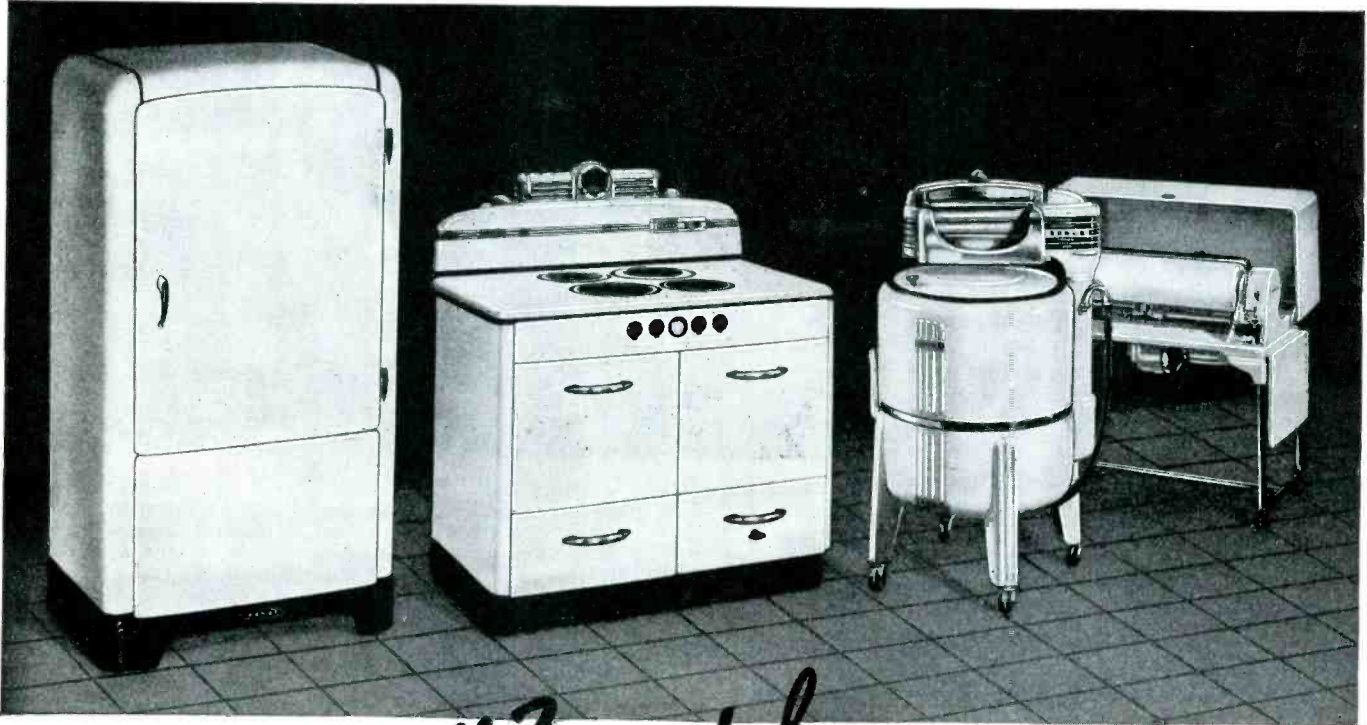

*Norgé offers all 3
essentials for a successful
Dealership*

BETTER PRODUCTS...

Every survey proves Norgé appliances lead in customer satisfaction. Norgé *consistently* ranks among the first three in public acceptance. The smashing new advertising and sales promotion program dramatizes exclusive features that you can demonstrate in your showroom.

NORGE DIVISION *Borg-Warner Corporation, Detroit, Michigan*

YEAR-'ROUND PROFIT...

There is always sales activity in the Norgé line of Rollator Refrigerators, Concentrator Gas and Electric Ranges, Autobuilt Washers, Duotrol Ironers, and package heating and commercial refrigeration equipment. Every month is a profit month for Norgé Master Merchants.

FREE TO APPLIANCE DEALERS!

A full volume on appliance selling and promotion. Describes a complete plan of store operation. Tells how to get the most out of advertising and sales promotion. Shows you how to make more money in the appliance business.

TURNOVER...

High product turnover and liberal finance plans keep your capital working for you all the time. Low dealer and salesman turnover proves men have found it profitable to sell Norgé and *stick to Norgé*. You owe it to yourself to get full details of the Norgé franchise without delay.



TP-3

MAIL TODAY!

NORGE DIVISION *Borg-Warner Corp.,*
654 E. Woodbridge St., Detroit, Mich.
*I would like to receive a copy of your new
book for appliance dealers.*

NAME

ADDRESS

CITY

STATE

Red Means Red

PHILADELPHIA—People who want a job in Philco's assembly line must first identify colored discs devised by Jap scientist Prof. S. Ishihara. Think what color-blindness could do to production with all those coded leads!

Branch For Anchor Lite

WHEELING—The Anchor Lite Appliance Company of Pittsburgh has just opened a new branch here at 16th and Main, will distribute Crosley products to thirty-four additional counties in southern Pennsylvania, northern West Virginia, western Maryland and eastern Ohio from the new office, with M. H. Marshall in charge.

New Association Heads

CINCINNATI—AT the recent annual meeting of the radio division, Cincinnati Electrical Association, Matt Williams of the Crosley Radio Corp. was elected president. Willard B. George of the Johnson Electric Supply Co. is vice-president Stanley Isaac of the Auto-Rad Supply Co. secretary and A. H. Schrage of the Fisher-Aeschbach Co. treasurer.

DuMont Imports Cat-Ray Book

UPPER MONTCLAIR, N. J.—To aid experimenters interested in the various applications of cathode-ray tubes the Allen B. DuMont Laboratories has imported a limited quantity of books from England. Entitled "The Low Voltage Cathode-Ray Tube and Its Applications," considered extremely complete and practical, these are being sold for \$4, postage prepaid.

Crider Advanced

LOUISVILLE—John J. Crider, associated with the Cooper-Louisville Company as special sales rep for the past eight years, has been elected vice president and director. He will continue sales and promotion work in Kentucky's bluegrass district.

Miller Promoted

CLEVELAND—L. H. Miller, for the past year manager of the Allentown, Pa. branch of the General Electric Supply Corp., has been named sales manager of the domestic refrigeration sales section of the General Electric Company, will make his headquarters here beginning December 1.

Pierce-Airo Expands

NEW YORK—Pierce-Airo, Inc., maker of DeWald radios, has just moved to larger, more modern quarters at 436-440 Lafayette Street. Increased demand for sets bearing this firm's popular trademark is given as the reason for the expansion.



TWO NEW STORES FOR PARTS BUYERS—(Top) Paul Chauncy, Ralph Walker and Russ Jimieson celebrate the opening of Walker-Jimieson, Incorporated's new store at 311 South Western, Chicago. (Bottom) Dean Wilhelm sells serviceman Wyatt Hester an oscillograph wobbulator right out of the window of his new store at 114 Hibbard Court, South Bend

Gallagher New RCA Rep

CAMDEN—Frank Gallagher has been appointed RCA Victor sales representative for Akron, Canton, Youngstown and Erie, operating out of the Cleveland office under the direction of district manager A. G. Kemp.

Cornish Expands

PATERSON, N. J.—The Cornish Wire Company has enlarged its wire production facilities, installing several new drawing machines. Offices are maintained at 30 Church Street, in New York City.



NEW KENYON S.M.—W. G. (Bill) Many, Kenyon Transformer's new sales manager, is one of the real old-timers in radio, has been advertising manager for Aerovox for the past six years



PERI-DYNAMIC HIS PLAYMATE—M. R. Jones, Jensen sales engineer, plays around at home with a tuner designed for quality rather than selectivity or sensitivity, works it into a new Peridynamic reproducer with bass reflex

Branch For Tube Distributor

AKRON—Radio Tubes Distributing Company of Cleveland, distributor of Tung-Sol tubes, also parts test equipment and general radio supplies, has opened a branch here at 270 Water, Mr. Schutz in charge.

Cinaudagraph Branch Moves

CHICAGO—The Cinaudagraph Corporation's Chicago office moved, during the holidays, to enlarged quarters in the Northeast Tower Building, 2018 W. North Avenue, 12th floor. Roy W. Augustine, representative, advises that the office's new phone number is Armitage 2409.

Arcturus Branch Moves

CHICAGO—To new quarters in Room 14112A of the Merchandise Mart goes the local office of the Arcturus Radio Tube Co. of Newark, N. J. More space, greater accessibility to fast transit lines are given as reasons for the move by resale division manent repair.

"Videotron"

NEW YORK—National Union, at present enlarging its cathode-ray tube research and production facilities, reports that it has established the trade-name "Videotron" as descriptive of these tubes. Special development work concerned with television applications is being carried on under the guidance of M. P. Wilder.

Stromberg In New Drive

ROCHESTER—The fourth Better Salesmanship Campaign for direct franchised Stromberg-Carlson dealers and their salesmen went into its stride January 2, under the direction of Jack Kennedy, sales promotion manager of the company.

Six valuable awards are dangled enticingly before dealers competing. Holder of the best sales record in each territory at the end of February earns, in addition, a new model 245M Labyrinth radio with electric flash tuning.

HOW TO SELL WOMEN

(Continued from page 15)

delightful sensation of having acquired the most beautiful and desirable set on the market, which good merchandising would have supplied.

Sell what it does, not what it costs

To sell radios from a price angle or a technical point of view to women is sheer waste of opportunity, for it means selling your product down instead of selling it up. If the price

per unit on kitchen stoves can be increased year by year through giving them glamour appeal, surely it should be child's play to do the same thing, and even more successfully, with radios. But anyone who wants to try it out needs, first of all, to know something about this glamour and its mysterious power to turn serious, budget-minded, saving-for-a-rainy-day women into arrant spendthrifts.

Glamour has its hold on women largely because of its strong appeal to their vanity and pride of ownership. Every woman loves to see herself in a glamorous role—in fact, she needs the reassurance of beautiful surroundings and fine things that belong to her as much as she does sweet nothings whispered under a June moon.

Of course a cheap radio, bought because it was a marked down bargain, isn't going to arouse much feeling that here is a thing of beauty worthy of her and any corresponding pride of ownership. On the other hand, if the lady knows that the model she has her eye on is an exceptionally good one, if she is aware that her dearest and most envied friend has the twin to it, if she realizes that it is more expensive than the average radio and is convinced that here she has an opportunity to pick up a rare and priceless treasure, she is going to want it—and have it, even if it means putting her family on bread and water till it's paid for.

Another urge, strong in every woman, is to please men—in particular her own special man. She herself might be contented with an inexpensive radio, substituting pleasure in saving money for pride of ownership. But just point out that such a set lacks the tricks to give the highly specialized performance that most men insist on and see how quickly she'll transfer her interest to a better radio.

Next, believe it or not, practically all women like a so-called perfumed atmosphere for shopping, even if they have to pay for it. The shops that cater to women know this well. Go into some of the big department stores and notice the gilt edge decorations. If you have the courage, drop into a smart beauty salon, where they extract two or three times what normally could be asked because they do it gracefully and with a regal air.

I have visited several radio shops which are run on the salon principle. The unit sale in these stores is two or three times higher than that in

the average jumbled cut rate store. And it's easy to understand why. You are seated in a comfortable chair, you are offered a cigarette. Then as the salesman shows you different models, you discuss opera, symphonies and concerts. The skillful salesman psychologist leads you out of any stingy \$20 mood in no time. Before you leave the shop you're not only willing but positively anxious to part with your whole bank roll in exchange for the culture and education represented by the \$200 model which occupies a place of honor at one end of the room.

Of course with many women a discussion of good music will not ring the bell at all. If the customer's young and pert and smartly dressed, perhaps a brief review and snappy comment on the latest hit song will do the trick. Again the gossip motive, so ably supplied by the radio, may be the appeal. Or the news angle and the opportunity to keep up with what's going on may be the note to strike.

But in any case if you talk price and technicalities to women, the bright, spendthrift mood fades into drab, remember-the-budget caution. Instead substitute glamour, beauty, pride of ownership, entertainment and the fuller life, and watch the grasp on the purse-strings relax and a gleam come into the eye—the gleam of desire to possess.

FIVE LETTERS ABOUT DISCOUNTS

(Continued from page 16)

you . . . for all business is inter-related. Surely . . . you will give this your personal attention.

LETTER No. 4

The butcher, the baker and candlestick maker

are mighty important cogs in the big business-family" that functions in this community.

When they close their shutters—the town suffers.

Right here in our midst there exists a practice tending to put these little (but mighty important) businesses out of business.

Yet there is nothing malicious about this effort—in fact the very men who are doing this are doing so unintentionally and unknowingly.

Let's get down to facts:

In ever so many industrial plants the employees are permitted (and often encouraged) to buy their radios—washing machines, refrigerators and other appliances

(Please turn to page 60)



Thorobreds perform better, show better—and so do the thorobred 1938 WARD automobile aerals, featuring Mol-en-ac, a natural white metal that cannot rust.

WARD aerals give more power, greater reception, smarter lines, less static — are easy to install.

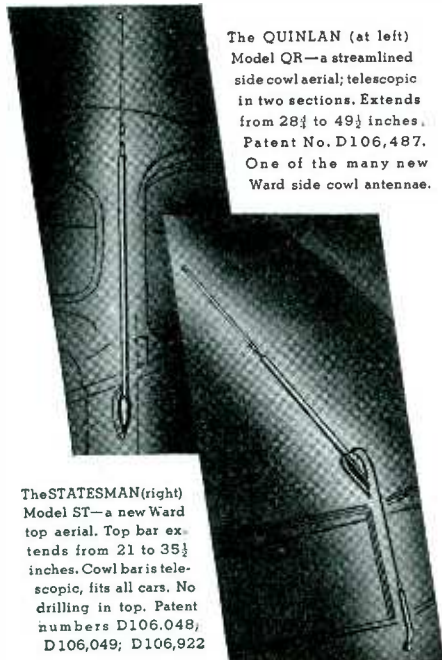

The QUINLAN (at left) Model QR—a streamlined side cowl aerial; telescopic in two sections. Extends from 28½ to 49½ inches. Patent No. D106,487. One of the many new Ward side cowl antennae.

The STATESMAN (right) Model ST—a new Ward top aerial. Top bar extends from 21 to 35½ inches. Cowl bar is telescopic, fits all cars. No drilling in top. Patent numbers D106,048, D106,049; D106,922

WRITE FOR ILLUSTRATED CATALOG

The WARD PRODUCTS Corp.
WARD BUILDING CLEVELAND, OHIO

(Continued from page 59)

at WHOLESALE through the company purchasing agent office.

We are in sympathy with the motive that prompts this . . . but for the fact that this movement to "buy it at wholesale" definitely deprives the retailer of a chance to earn a living.

He must sell to the Tom Browns—the Henry Joneses—the John Smiths to continue to live. If that market (the average man) is taken from him he must close his shutters and

.....here's the joker..... the community (and that means You) is then forced to support him.

Just a thought . . . Suppose you tell us how you feel about it?

LETTER No. 5

"We'll run our business as we ***** please". Yes sir! you certainly can . . . up to a certain place. And then the inevitable law of compensation begins to go to town. Just as you cannot destroy game without destroying the balance of nature so the laws of business as operated in this country demand a certain balance.....

...the balance of supply and demand.
...the balance of production and sales.
...the balance of BIG BUSINESS and little business.

This is the fifth of a series of letters asking you to kindly consider the relation of the small independent merchant and the purchasing agent who buys "at wholesale" for employees to the ultimate death of that small merchant.

Many of Milwaukee's business and industrial executives have written to say . . . "You're right . . . we'll call a halt."

And so we respectfully call this situation to your attention again in the hope that you too will see the obvious need of keeping that balance of business . . . a balance that has made this the greatest country in the world.

Won't you try to "think this out" with us.

REFRIGERATION

(Continued from page 35)

(1) *They lack the right motivation.* If the salesman is not sold on the use value of the appliance he is selling, his story will lack conviction.

(2) *They are confused by complex methods.* Prospects may be found in 56 different main classifications such as license records, voting lists, club memberships, payrolls, permit records and the like. Keep it simple.

(3) *They don't look around enough.* The prospect you are looking for may be the man right next to you.

(4) *They don't keep their friends working for them.* The wife, the family, your business associates may all be good sources of prospect material.

(5) *They don't provide a planned number of prospects for each day's demonstrations and closures.* You've got to have a set number for each day or the average of calls, demonstrations and sales will drop.

These are the five common mistakes. Watch out for them. And then pin this in your hat—it has been proved—there are four principle sources of prospect supply: Acquaintances, users, selective canvass and telephone canvass. If your efforts are concentrated on those four you will be tapping the main source of supply.

Making the Sale

All right, you've got your prospect. If you know the rest of the steps he is half sold before you begin. And whether it takes one interview or a half-dozen, you've got to get him or her to react favorably to five things:

1. **The need of the product.**
2. **The preferred ability of your refrigerator to answer it.**
3. **That your store is the best place to buy it.**
4. **That the price and terms are right.**
5. **That the best time to buy is now.**

Here's how to go about it. To gain attention, talk about the most arresting, striking thing in your story. If it is food savings of 20 per cent, okey. If it is the health angle, okey again. Experiment around until you find it. To create interest, describe the need. This includes pleasure, protection, freedom, economy, use value, satisfaction and savings. Expand on all of them. Third, to arouse desire, sell the advantages of your particular product. Make the prospect feel that *your* refrigerator and only yours has all the unique advantages and distinctions to provide her with the benefits you have already described. Fourth, to establish her confidence, provide proof of the value of your refrigerator through testimony of present users, from your manufacturer's laboratory tests and from the experience of countless other users in the field. The final step, of course, to get the order is to persuade the prospect to buy which, if the other steps have been carried through and every point has been understood, will result in the completed sale.

The Importance of Demonstration

A lot of salesmen have the notion that making a demonstration means placing the prospect in front of the
(Please turn to page 62)

BIGGER AND BETTER THAN EVER AND STILL **FREE**

TO RADIO DEALERS AND SERVICEMEN!

3rd Revised Edition of

"TRICKS OF THE TRADE"

Contains accurate answers to 956 set troubles
— 11 reference charts — 24 auto circuits

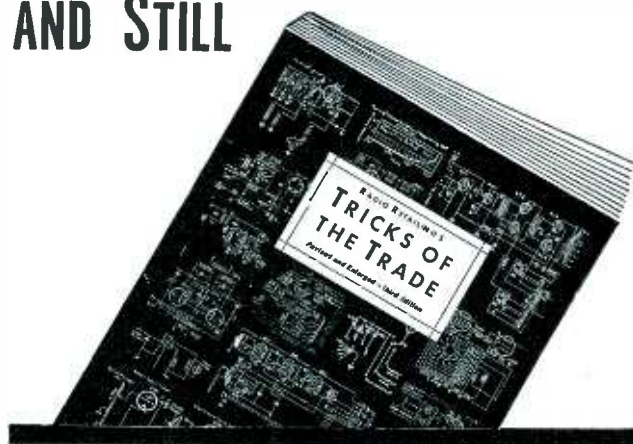

SAVES YOUR TIME! SAVES YOUR MONEY! ENDS SET WORRIES!

HUNDREDS of radio men are using this unequalled, trouble-shooting guide to take the "bugs" out of their toughest repair jobs and pour EXTRA profits into their service work. Already in its third edition, "Tricks of the Trade" has really clicked. But it should. It contains not one bit of useless data, no waste descriptions, no theories, no help for fans or amateurs. Every one of its 76 pages is packed with practical, "how to" information that answers the questions on set troubles that crop up in your work every day.

"Tricks of the Trade" is one service book that is different. Once you have had a copy you won't part with it for a minute. I know many men who consider it more valuable than their tool kit. This one, new edition contains:

- 956 tested ways of finding and fixing the troubles common to specific makes and models.
- 102 tube socket diagrams showing the connections for more than that many types of new tubes.
- Valuable reference charts showing—why service can't be cheap—types of auto aerials—analysis of common set troubles—24 automobile ignition circuits—why servicemen charge for inspection—and others.

● Why are these "Tricks" good? Because every one of them came right from the actual

experience of professional radio experts. (See typical examples in column to right of page.) Why spend hours of your time testing and re-testing a balky circuit, when, with this new book, you can put your finger on the most probable cause of the trouble in a few seconds.

● These "Tricks" will show you how to spot a lot of set troubles that don't show up in any circuit tests you make. If your time is worth money and you like to duck plenty of grief—get yourself a copy of "Tricks of the Trade"—today. **IT IS FREE IF YOU ACCEPT THIS OFFER NOW.**

HOW YOU CAN GET FREE THIS VALUABLE BOOK

- Simply fill in and return the order blank below with the subscription fee to cover one year of Radio Retailing for \$1 or three years for the reduced rate of \$2. The new editions of "Tricks of the Trade" is included as our gift.
- This book is not for sale separately. Credit orders cannot be accepted. Be sure to enclose remittance with your subscription order. ACT NOW. This new edition is going fast. Don't be sorry. Do it today.

Time-Saving Information

Certain radio sets develop trouble peculiar to their particular type of circuit. Each month "Tricks of the Trade" explains how to locate and fix specific set failures. The following are examples of the curt practical way Radio Retailing offers this vital information to you.

BREMER-TULLY, BRUNS-WICK 58

Bad volume control . . . Often due to fibre projecting too high, causing rotor arm to miss. Push fibre down before replacing control.

CLARION 60, 61

Set dead or very scratchy . . . Look for failure of special audio input transformer primary. Replace with same device or substitute resistance coupling. Tone will suffer if ordinary transformer is used for replacement due to special characteristics of original.

CROSLY 143

Neon pilot lights when set switch is in Off position . . . Replace leaky 8 mike, 150 volt condenser.

MOTOROLA 77

Poor tone . . . Check to see if voice-coil or field wires have been reversed. This causes voice-coil form to become blackened and charred inside due to heat. If swollen, discolored appearance is noted replace.

RCA 120

Operates at low volume on strong signals, intermittently comes up to good volume . . . Check .05 condenser between center terminal of volume control and control grid lead of 2B7 second detector.

Every issue of Radio Retailing will bring you more of these "Tricks". File them and in a short time with this FREE book you'll have a service manual of un-equalled value.

Mail this coupon and payment—Today!

FREE-BOOK SUBSCRIPTION ORDER FORM

PRESENT SUBSCRIBERS NOTICE

Present subscribers may obtain a copy of this FREE book by renewing their present subscription. Regardless of when your present subscription expires, you must send in another PRE-Paid renewal order. Your subscription will be extended for additional time without duplication. No previous renewal orders count. We must show a matching order for every book sent out. Mail in your order and payment today.

This offer only applies to U. S. and possessions, Canada, Mexico and Central and South America. All other countries add 50c to foreign rate of \$2 a year to cover postage charges on book.

All books are sent out by express to insure safe delivery. There is a small handling charge of 15c—payable to the expressman upon delivery of the book. If you prefer book sent prepaid, add 15c to the subscription fee at time of ordering.

O. K. Attached is \$2 for a 3 year subscription to Radio Retailing. With this order I am to get a FREE copy of the 76-page service book—"Tricks of the Trade". I'll pay the expressman 15c for delivery charges. Send the book at once. Check here if this is renewal order.

Name..... Position.....

Street

City..... State.....

Our Main Business Is.....

Check here and remit \$1 if you wish only one year subscription PLUS FREE book. 1-38

No orders accepted without payment attached

RADIO RETAILING
330 West 42nd Street
New York, N. Y.

This offer void after May 1st, 1938

Pin
\$1 or \$2
Here

(Continued from page 60)

appliance so that she may admire it. Figure how far you would get in a radio set demonstration using that technique. Demonstration does not consist of exposing the prospect to the appliance; it consists of *exposing the appliance to the prospect*. Let's see why that is important.

A thousand housewives were asked in a recent survey what dominating influence *initiated* purchasing interest in a refrigerator. The score was 89 per cent for advertising and 11 per cent for personal selling. But when the same thousand women were asked what dominating influence caused them to reach a purchasing *decision*, the score was 94 per cent for salesmen as against 6 per cent for advertising. And when these same thousand women were asked to check the item that most influenced that buying decision, they reported that demonstration accounted for 86 per cent as against 14 per cent for selling talk.

Now demonstrating takes in all the senses—seeing, hearing, feeling, tasting, smelling—and manipulating. It's that last one that is universally forgotten. The women must be given the opportunity to get their hands on

the refrigerator. The sequence is—tell, show, try.

There are six kinds of demonstrations:

(1) Where the salesman shows all the product features while the prospect sits and looks on.

(2) Where the salesman gets the prospect to participate in demonstration by handling or manipulating one or more parts of the refrigerator.

(3) Where the salesman expands on the subject of the loss caused the family by not having the refrigerator—loss in health, convenience, pleasure and economy. This is a kind of absent treatment demonstration based on the assumption that the prospect is not thinking of buying a refrigerator.

(4) Where the salesman makes the prospect feel that the refrigerator is already hers and demonstrates as though he were showing her some of the fine points of the appliance she has bought.

(5) Where the salesman uses the comparison method. This can apply to both the situation of the prospect with and without a refrigerator but can also include the type of demonstration that emphasizes the virtues of this particular box as opposed to a competing make on the market.

(6) Where the salesman resorts to charts and graphs to explain the operation or simplify the sales story as to the inherent advantages that go with ownership.

And then, of course, there is the proven method of home trial itself which, by its very nature, is bound to have the greatest effect on the housewife. Most effective but most expensive, too.

Meeting Objections

The measure of success any refrigerator salesman achieves is the amount of resistance from the prospect that he can overcome. Anybody can go through a stereotyped sales presentation; the good salesman knows how to clear the hurdles of objections as they are raised.

Objections, generally, may be said to originate in six different ways:

(1) In these days of comparative buying, it is possible that the product you are selling is wrong. If the product is not nationally known and lacks sales features you are at a disadvantage.

(2) A good many salesmen knock competitors and objections brought up may have arisen from this source. Fashion your presentation around the

*Modern
Miracle*
**The COMPLETE
WASH-SYSTEM**
with
Kleenette
by HORTON

● Two washers for very little more than the usual price on an ordinary conventional type washer alone—*that's what you get* in a HORTON Complete Wash-System.

The oversize Horton KleenZONING machine is for the once-a-week general family washing. The small *Kleenette*, which operates inside the big machine, is your "personal washer" for laundering fine fabrics, sheer lingerie—for home dry cleaning—for tinting and dyeing—for boiling and sterilizing baby's things or linens from a sickroom—for every sort of between-times cleansing job.

Only HORTON can give you the KleenZONING Washer and the new *Kleenette*. Don't buy until you see them.

DEALERS! Get the profit story in Horton's complete wash system and the full line of Horton Beauty-Aid Ironers. Ask your authorized distributor or write

HORTON MFG. CO., 106 Osage St., FORT WAYNE, IND.

- **Build Profits**
- **Satisfy Customers**
- **Flexibility to meet EVERY requirement**

● REMLER

INTER-COMMUNICATION SYSTEMS

Build a permanent and worthwhile business with *profitable* Remler systems. Priced to meet competition with new features which are not available in other systems, regardless of price!

Modern styling . . . bakelite cabinets . . . superior station selector system . . . high intelligibility . . . approved by Underwriters' Laboratories. Prices start at \$49.50 for two station systems.

REMLER—SINCE 1918

Remler Inter-Communication Systems are backed by the reputation and stability of a trustworthy firm continuously under the same management for twenty years. Write for catalogue sheets, price lists, illustrated folders, sales helps and name of nearest distributor.

REMLER COMPANY, Ltd., 19th at Bryant, San Francisco

plus values of your product and put them on the defensive.

(3) Selling gets to be old stuff after a while and you may have tried to sell too fast thus failing to tell the story of all your product's advantages. Remember that your job is to know everything about your product and deliver it.

(4) The prospect may want to buy so much that she throws up objections in defense. Such expressions represent interest in disguise. Stick to your story.

(5) Maybe the prospect dislikes you personally. Remember always to trade the prospect up and yourself down.

(6) The prospect may not like dealing with the company you represent. Do your best to overcome any mistaken impressions that may have been created.

Using the Satisfied Customer

An analysis of reports from 384 salesmen recently showed that 72 per cent are ignoring values accruing after the sale is completed. Only 12 per cent try to get testimonials from users; 22 per cent use owners as reference in a hit-and-miss fashion; 52 per cent attempt to get leads from owners. This relatively poor showing (and remember that salesmen are only about 20 per cent effective out of a possible 100 per cent!) means that they are throwing away these values in connection with using the user:

(1) They are selling a product rather than ultimate satisfaction (2) They'd rather make a sale than make a customer (3) They are content with mediocre earnings rather than with multiple earnings.

Briefly stated—and most of this article is being stated just about as briefly and concisely as we know how—there are a few rules to keep in mind when cultivating the present user to get future business:

(1) Get the user to talk. Pride of ownership will start a lot of conversation with her friends.

(2) Make the user feel a friendship obligation. If you have sold her right, she will feel it her bounden duty to get her friends to buy.

(3) Get testimonial letters from users. This is the strongest kind of proof you can use on future buyers.

(4) Get permission to refer to users. Don't annoy your old customers arbitrarily.

(5) Encourage your old customers to furnish prospects. A friendly contact once or twice a year should

yield three prospects in the same period.

(6) Get each user to help you with new sales. This is best done within 90 days of the sale as the news is still fresh.

There it is, short and sweet. And it pays dividends.

WHAT ABOUT FACSIMILE

(Continued from page 23)

to a third of this figure. But by the time recorders are generally available and in demand, the situation may have changed so considerably that it is unwise to prophesy. Marketing, distribution and sales problems still remain to be worked out. With radio outlets already established there does not seem to be any reason why facsimile equipment would not best be handled through the usual radio outlets, as are phonographs.

The present facsimile equipment for home use is considerably less complicated than modern superheterodyne receivers. The well equipped service man, or perhaps a trained mechanic, should be able to make whatever repairs or servicing is required. The actual recorder for producing the image is more a mechanical than an electrical device, and it is likely that service requirements will be few and far between.

The operation of the recorders is not such as to cause difficulty to one who can operate a radio receiver. While some of the recording processes in the past have required photographic processing of one type or another, such a system has definite disadvantages for general home use. It is possible to build up images directly by a process of electrochemical decomposition of specially prepared paper, or by contact with carbon sheets. Such methods require no processing subsequent to reception, and indicate the probable trend of future developments.

How soon will the radio newspaper be available to the average home? The answer to that question may be contained in a statement made by the manager of one progressive station who says: "We are marking time until set manufacturers make satisfactory house facsimile receivers available through the regular commercial channels. When that time comes, we hope to go ahead again with a planned program of facsimile experimentation."



Crowe FIVE-POINT PROGRAM

For Crowe
On-the-Panel Controls

YOUR Philco Distributor — again in 1938! — has a special Crowe Program to help you increase your sales of Auto Radios.

This Crowe Five-Point Program insures quicker sales and increased profits with Crowe ON-THE-PANEL Kits — at no extra cost.

Crowe 1938 On-the-Panel Kits embody these features:

- Exact custom styling
- Official Philco specifications
- New no-glare dials
- Improved anti-backlash design
- Adaptable to any car
- Quickly installed—easily moved

Ask for Crowe Bulletin No. 205

PARTS JOBBERS!

Enlarge your market—increase your sales! Radio Dealers—New-Car Dealers—Used-Car Dealers. ALL need Crowe On-the-Panel Controls—for modernizing or changing old radios from car to car.

Ask for Bulletin No. 206

CROWE NAME PLATE & MFG. CO.
1745 Grace Street
CHICAGO, ILL.

TELEVISION

(Continued from page 20)

tan area. As a result of continuous experiments under actual service conditions the transmitting antenna and much of our other equipment has been remodeled several times.

Week by week and month by month television engineering progress has seemed slow and difficult. Yet when we look back today over the relatively short period that separates us from our first television field tests we can observe a number of definite and promising achievements.

Whereas in 1936 each separate image was scanned with 343 lines, today we are scanning with 441 lines. This standard of picture-definition is now generally regarded as satisfactory. During the past year the color of television pictures has been changed from green to black-and-white and their brilliance greatly increased. The size of the picture has been increased from approximately 5 x 8 inches to 7 x 10—almost double the area. In addition, important progress has been made in projecting television pictures of approximately 3 x 4 feet onto a screen. Kinescopes and other articles of television equipment have recently been made available to amateur experimenters.

These are some of the technical advances in television accomplished by RCA engineers during 1937. Meanwhile, the broadcasting service of RCA—the National Broadcasting Company—has been operating an experimental television studio in the RCA Building and has also made significant progress in the development of television programs. Lighting and make-up, sound effects,

scenic design and studio architecture, as well as the manipulation and coordination of television cameras, have been the subject of continuous study and experiment by NBC engineers and program specialists. New techniques for the writer, the director and the actor are being explored. Practical experiments with outside television pick-up equipment are now under way. It has become apparent that the television program must blaze many new trails in order to develop a form of presentation fitted both to the scope and limitations of the new medium.

Ultimately television will create its own individual art form—a fresh and unique world of illusion. It will supplement the older arts of stage, motion picture, and sound broadcasting, and supersede none.

In the world of creative and expressive art the hardest question which television propounds is that of supplying talent. Television broadcasting, even more than sound broadcasting, will be the great consumer of art. It will constantly demand more and better writers, musicians, actors, and scenic designers—new thoughts, new words, new songs, new faces, new backgrounds. Unlike a play on the stage or a motion picture which may be run for a year, the television program, once it has been shown to a national audience, is on the scrap-heap. It is finished. Television will call for a whole new generation of artists.

In evolving a satisfactory program technique we have already learned that television programs will cost much more money than sound broadcast programs. If television programs are to be provided through the support of commercial sponsors, advertisers must first be furnished with

sufficient circulation to justify their expenditures. Here we have the dual problem of simultaneously creating a cause and an effect: we must create large audiences in order to support costly programs, and we must build costly programs in order to attract large audiences.

To meet the requirements of a nationwide television service, vast sums of money must be invested in new facilities. The present range of useful television signals is less than 50 miles. The creation of even limited networks, with connection by coaxial cable or radio relay, is a highly expensive undertaking. As in every other pioneering development and rapidly changing art such investments cannot be made without risk. I believe, however, that the same American pioneering spirit of private enterprise which has given us great systems of transportation and communication, and has produced the great industries of the automobile, motion picture and radio, will likewise provide us with a nation-wide system of television.

Radio has already furnished extensive employment to both capital and labor. In television, the newest child of the radio art, we can foresee another vigorous industry which will provide many new avenues of employment, and will furnish opportunities to the younger generation looking for careers in new fields.

We can, I believe, look forward to the ultimate establishment of an American television system, which, like our present system of sound broadcasting, will employ many thousands of workers, will offer a unique advertising service to American business, and will render a free educational and entertainment service to the public.



NEW MUELLER RADIO CLIP KIT!

A complete and handy outfit for the radio shop at a bargain price.—See it at your Jobber's or write factory for details.

ASK US FOR NEW
1938 CATALOG 701

Mueller Electric Co.
1584 E. 31st St.
CLEVELAND, OHIO

Janette Rotary Converters



The original D.C. to A.C. converters with all wave filters developed exclusively for radio and sound apparatus.

CAPACITIES: 35 to 3250 watts.
6, 12, 32, 115 and 230 volts
D.C. to 110 or 220 volts, 1 phase,
60 cycle A.C.

Insist on a Janette
Ask For Bulletin No. 13-25

Janette Manufacturing Company
556-558 West Monroe Street Chicago, Ill. U. S. A.
BOSTON - NEW YORK - PHILADELPHIA - CLEVELAND - MILWAUKEE - LOS ANGELES
DETROIT - SEATTLE

Revolutionary

SELF-STARTING, ELECTRICAL
NUMERAL CLOCK



CHIEFTAIN

Every person who comes into your store will want one . . . everybody can afford one . . . nearly everybody will buy one . . . because this wonder electrical numeral clock

Chieftain is tomorrow's clock today! The evolution of two modern miracles . . . the modern clock and modern plastics. Wins friends immediately . . . makes customers quickly . . . for other long-profit goods, too. "Shoppers go home with a Chieftain instead of a 'price quotation'". No sales let-up as long as there's a Chieftain in your store! High trade-up value. Ask your distributor for details of Pennwood's attractive dealership proposition . . . or ask us direct.

Sells on Sight

Pennwood spent \$100,000 to perfect Chieftain . . . the electric numeral time-teller that is opening new profit opportunities for alert radio dealers. The product of a \$100,000 investment in electric clock research. Hundreds of improvements give it a big jump over all other time pieces. For home, office or shop use. Most modern of all time pieces! . . . A sensational value that will make more money for you!

TO RETAIL WITH PROFIT - AT A NEW LOW OF

THE PENNWOOD COMPANY
Pioneers of Numeral Clocks
7525 Kensington St.
Pittsburgh, Penn.

TRUE TIME TELLING QUALITY
WITH VOLUME BUILDING PRICE!

COMPLETE WITH CORD AND CONNECTOR
\$ 4⁹⁵

A MESSAGE TO THE RADIO TRADE OF AMERICA

There seems to be much speculation in the trade as to: "What is Frank Andrea going to do?" I would like to answer this question very simply.

The success of F. A. D. Andrea, Inc., under my management and ownership, from 1920 to 1932, was achieved by our close-knit cooperation with our jobbers and their dealers under merchandising methods which assured them of adequate profits, and protected them from destructive price competition and end-of-season dumping.

For the last 4 years, the Andrea Radio Corporation has manufactured equipment for overseas distribution only. We have made tremendous investments in circuit research and design, and in improved production methods, much of which are entirely new in this country.

The purpose of this investment was to meet the extreme requirement and conditions of reception in remote parts of the world. The result is that Andrea Radio overseas models are considered today the finest receivers manufactured in the U. S. A.

Now, reentering the domestic market, we are adapting these engineering achievements as rapidly as possible to models designed specifically for sale in this country. They are being distributed through jobbers under the plans and policies that brought us the loyal support of the radio trade in the past, with adjustments necessary to meet present-day conditions.

I invite your inquiries for more complete details.

F. A. D. ANDREA, President

Andrea Radio

ANDREA RADIO CORP.
4821 — 48th Ave., Woodside, L. I., N. Y.

For Super Service - HICKOK TESTING INSTRUMENTS



NATIONALLY APPROVED
Greatest Accuracy
Wider Ranges
More Useful Features

NEW OSCILLOGRAPH, RFO-4— MORE THAN TWICE AS USEFUL

Think what that means—complete coverage of all stages. Self-contained Demodulator makes it possible to use Oscillograph in both RF and IF stages. Single or consecutive stage by stage trouble shooting from antenna post to speaker. Self-contained electronic frequency modulator, return trace eliminator, and all other features necessary for laboratory and service measurements.

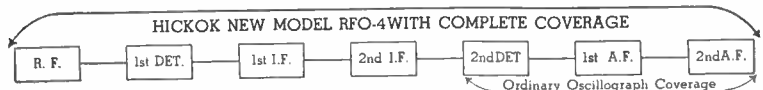

COMBINATION TUBE AND SET ANALYZER



A combination of the Hickok AC51 Dynamic Mutual Conductance Tube Tester and Model 4800S wide range Zero Current Set Analyzer. Measures D.C. Volts at millions of ohms per volt. All other necessary ranges for radio and sound system servicing. If you are not familiar with the Hickok methods of set analysis and tube testing use the coupon or write for complete information.

NEW SIGNAL GENERATOR with OUTPUT CALIBRATED IN MICROVOLTS



Hickok Model PSG-15 has a built-in calibrated output and power level meter. Output standardized by built-in vacuum tube voltmeter; calibrated 1/2 to 100,000 microvolts R.F. and 0 to 1.0 volt A.F. on all ranges. Three decibel ranges, -10 to +38. Indicates gain per stage, selectivity and sensitivity. Radio frequency ranges are calibrated directly 85 K.C. to 28 megacycles; direct reading scales 100 inches long.

EASY PAYMENT PLAN, IF DESIRED.

THE COMPLETE LINE OF HICKOK INSTRUMENTS
Set Testers • Tube Testers • Oscillographs • Modulators • Appliance Testers
Oscillators • Panel Meters • Volt-Ohm-Milliammeters • Capacity Testers

THE HICKOK ELECTRICAL INSTRUMENT CO.
10514 DUPONT AVENUE • • • CLEVELAND, OHIO

SEE YOUR NEAREST DISTRIBUTOR

MAIL THIS COUPON

THE HICKOK ELECTRICAL INSTRUMENT CO.
Cleveland, Ohio

Please mail Radio Service Instrument catalog to

Name _____

Address _____

City _____ State _____

TECHNICAL TOPICS

SERVICE • SOUND • CIRCUITS • INSTALLATION • PARTS

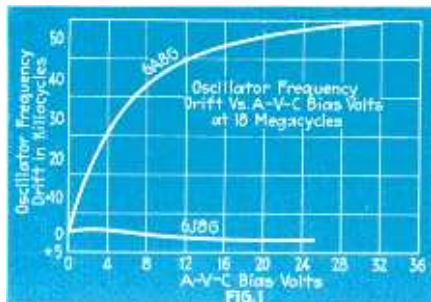

Improved Converter Tube

Pentagrid converters of the 6A8 type have certain limitations at high frequencies. Prominent among these are frequency drift due to applied avc voltage and line voltage changes, also relatively low gain on short wave bands. The new 6J8G, a triode-heptode, shows improved performance as a converter over former types as outlined in a bulletin by Sylvania. The triode and heptode elements are separately assembled, however, they are mutually connected at the cathode. Automatic volume control voltages when applied to the control grid of the heptode mixer will not materially affect the frequency of the oscillator section. Reference to Fig. 1 will show that for fairly large values of avc voltage the frequency drift of the 6J8G is less than one-twenty-fifth that of the 6A8G. These data were

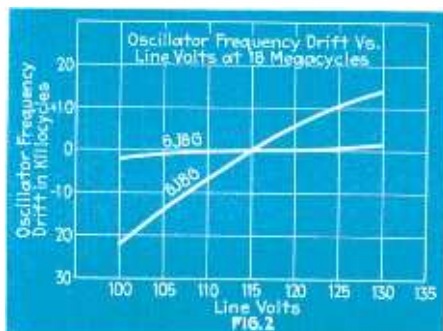

taken at 18 megacycles using a conventional tuned-grid, shunt-fed oscillator.

Fig. 2 indicates that, under the same conditions as those of Fig. 1, the 6J8G will have a frequency drift of less than two kilocycles for a line voltage variation of as much as fifteen volts in either

direction, while the 6A8G may cause a drift of up to ten times this figure.

The incorporation of a suppressor grid in the heptode mixer section gives it a high plate impedance. This factor, and the low input loading of the tube, allows full advantage to be taken of optimum antenna and i-f transformer design for the realization of high gains. Experimental data show that when such circuit components are used Types 6J8G and 6A8G have practically the same translation gain and overall stage gain at standard broadcast frequencies. At higher frequencies, up to 18-20 megacycles, these values for the 6J8G are substantially the same as at broadcast frequencies, whereas, at 18 megacycles the overall stage gain using a 6A8G may be less than one-third of that realized at 1500 kilocycles. These differences are due partially to the better

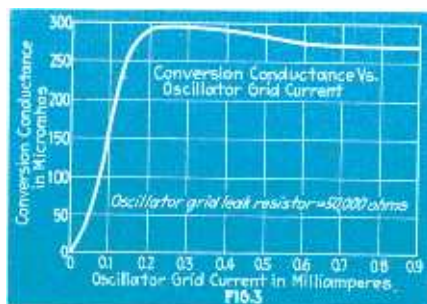

conversion efficiency obtainable with the 6J8G, and to the low input loading of the tube.

For optimum receiver performance too much emphasis can not be placed on the curve of Fig. 3. This gives the variation in conversion conductance for oscillator grid current with a 50,000 ohm grid leak and shows how important it is to keep the minimum oscillator strength above the knee of the curve. Attention is called to the fact that beyond the knee of the curve the uniformity is excellent over a wide range of oscillator voltage.

Although the rated conversion conductance of the Type 6J8G is lower than that of Type 6A8G, it should be remembered that, while conversion gain is a function of conversion conductance, it is also a function of load impedance of the converter section.

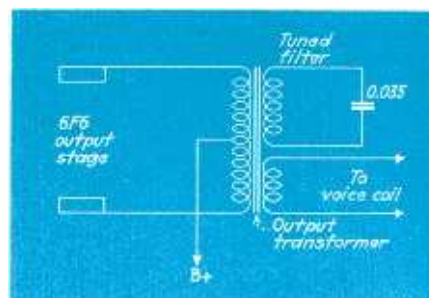

Selective Audio Transformer

Most high fidelity receivers are equipped with some sort of audio filter to provide a sharp cutoff at the upper end of the frequency range. Such is the tuned output transformer on the new RCA U-105, U-107.

The pushpull 6F6 output transformer has a third winding which is tuned by .035 condenser shunted across the terminals. The combination of inductance and capacity are such that high frequencies above a given frequency are absorbed by the tuned circuit. The action of the filter is similar to a wave trap in the antenna circuit.

The resonant frequency of the circuit is sufficiently high to be out of the useful audio range. Frequencies in this range are usually destroyed by static and interstation interference. The filter circuit removes these extraneous noises.

Antenna Selector Switch

The new Philco auto radio is constructed to allow maximum transfer of antenna signal regardless of antenna capacity. A switch in the antenna circuit connects the antenna to a tap on the coil when the capacity of the antenna circuit is great. This position is used for the "Roadway," undercar, and other high capacity systems. The other position, marked "Skyway" in the diagram, is for low capacity rod-type antennas.

In practice antennas may be divided into two classes, high-capacity and low

CIRCUITS

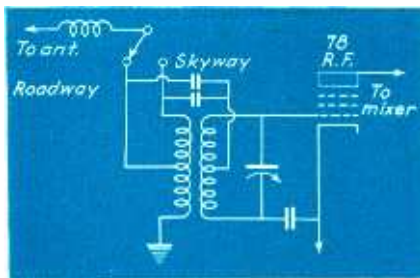

capacity. By providing the proper coupling system for each type the receiver so designed becomes universally adapted to any installation.

High capacity antennas offer a fairly low terminating impedance. Hence the switch should be thrown to connect the antenna with the tapped portion of the coil. Low capacity systems have a high impedance value so that the total coil should be used as a termination.

Three Mikes in One

On page 72 of the December issue the Shure Brothers "Tri-Polar" microphone model 720A is listed in such a way that it might be assumed there are three separate types. Actually, one microphone provided with a switch may be made non-directional, uni-directional or bi-directional.

This company also furnishes additional details in the way of footnotes applying to columns of data about its products appearing in the Microphone Listing. (1) In the "Impedance" column, impedance figures given are the values of terminal resistance to be used. (2) In the "Output" column, open circuit level is given in db below 1 volt per dyne per square centimeter. (3) In the "Output Volts" column, output volts is for 10 bars pressure (representative speech) into recommended load impedance. (4) In the "Frequency response and variation" column, model 720A used in bi-directional condition, low frequency response depends on distance between source and microphone. (5) In the "Directivity" column, directivity is considered in both horizontal and vertical planes.

Push-Button Assembly

Push-button popularity has created a new angle for certain manufacturers. Tuner units are beginning to appear, the model shown here is the work of Sprague Specialties. It is a 4 button 2 gang trimmer type suitable for a small superhet.

Connection to a receiver is made with

three wires; one to the oscillator, one to the converter, the third is grounded. Pushing any one button simply shunts capacities across the receiver's tuning circuits.

Condenser adjustment in the model shown is made with an aligning screwdriver inserted in holes above and below the push-buttons. Some models have provision for rear adjustment, this removing the necessity of openings in the front panel.

Capacity drift due to heat is comparatively small. A single film trimmer with capacity range of 10-80 mmf. shows a change of 0.6 mmf. Trimmers with 2 films or more drift approximately 0.6 per cent. Units are available in sizes up to 8 button three gang types.

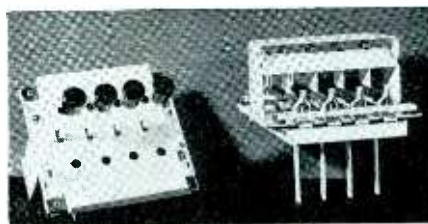

New Tubes

VR 150.—A gas filled, cold cathode voltage regulator by Sylvania. It is characterized by a practically constant internal voltage drop across which a load requiring good voltage regulation may be connected.

In all uses a current limiting resistor should be connected in series with this

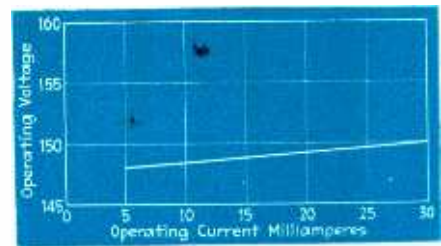

tube and the supply. The amount of current drawn by the load will determine the size of this resistor. It should be such that an operating current of not more than 30 ma. would flow through the tube in case the load is disconnected.

Characteristics are:

Minimum starting voltage	180 volts
Operating voltage	150 volts
Minimum current	5 ma.
Maximum current	30 ma.

6J8G.—Triode Heptode Converter by Sylvania so designed as to avoid oscillator frequency drift with changes in applied avc voltage. It may be compared to the 6A8G although not interchangeable in all cases. Interelectrode capacity is less than the 6A8G. High conversion gain is maintained at frequencies of 18 m.c. and above; ratio of signal to noise is materially improved.

Characteristics are:

Heater Voltage	6.3 volts
Heater Current	3 amp.
Plate Voltage (Heptode)	250 volts
Screen Voltage (Heptode)	100 volts
Grid Voltage (Heptode)	3 volts
Plate Voltage (Triode)	250 volts
Grid Resistor (Triode)	50,000 ohms
Plate Current (Heptode)	1.2 ma.
Screen Current (Heptode)	2.8 ma.
Plate Current (Triode)	5 ma.
Grid Current (Triode)	4 ma.
Plate Resistance (Heptode)	4 megohms

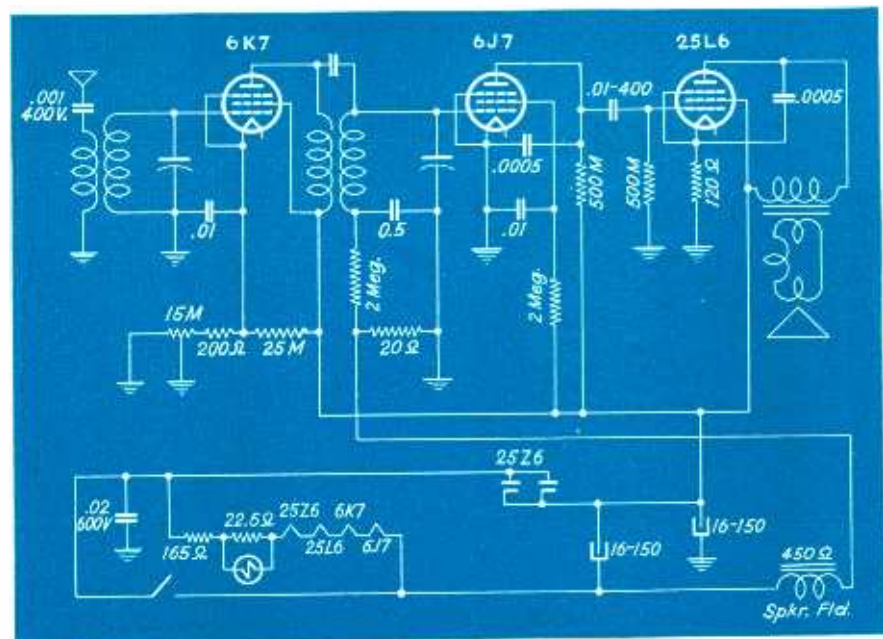

COMPRESSED RADIO—The schematic of Detrola's "Pee Wee"; an ac-dc midget with beam output tube and dynamic speaker, all within its 5½ in. wide by 4¼ in. high cabinet

AMATEUR NOTES

6F8G—A dual triode by Ken-Rad and Sylvania consisting of two type 6J5G triodes in the same bulb. The grid, plate and cathode of each triode are brought out separately thus permitting adaption to special designs. The voltage between heater and cathode should be kept as low as possible if direct connection is not made.

OPERATING CONDITIONS AND CHARACTERISTICS

CLASS A AMPLIFIER

Heater Voltage AC or DC.....	6.3 Volts
Heater Current.....	.6 Volts
Plate Voltage.....	250 Volts
Grid Voltage.....	-8 Volts
Plate Current.....	9.0 Ma.
Plate Resistance.....	7700 Ohms
Mutual Conductance.....	2600 Ohms
Amplification Factor.....	20

TYPICAL OPERATION AS PHASE INVERTER

Plate Supply Voltage.....	100	250 Volts
Grid Voltage.....	-2.25	-5.5 Volts
Plate Current per Section.....	1.5	2.4 Ma.
Plate Load Resistor per Plate.....	30,000	50,000 Ohms
Self-Biasing Resistor.....	750	1,150 Ohms
Voltage Amplification.....	26	29
Maximum Output Voltage (RMS).....	20	65 Volts

6U7G—A triple grid super-control amplifier tube by RCA similar to a 6D6. Internal shield in dome is connected to cathode.

Class A Amplifier Characteristics

Heater Voltage.....	6.3	volts
Heater Current.....	.3	amp.
Plate Voltage.....	100	250 volts
Screen Voltage.....	100	100 volts
Grid voltage (min.).....	-3	-3 volts
Suppressor.....	Connected to cathode	
Amp. Factor.....	375	1280
Plate Resistance.....	.25	.8 megohm
Plate Current.....	8	8.2 ma.
Screen Current.....	2.2	2 ma.

Characteristics As Mixer

Plate Voltage.....	100	250	volts
Screen Voltage (Max.).....	100	100	volts
Grid Voltage.....	-10	-10	volts
Grid bias shown is minimum for oscillator peak voltage of 7 volts.			

1A4P — 1A4T—Two super-control r.f. amplifiers identical in element construction to the 1A4. The letters "P" and "T" are used to differentiate between pentode and tetrode. The 1A4P has a suppressor connected internally to the cathode.

6G6G—A cathode-type output pentode by Ken-Rad. For low output requirements where maximum efficiency is of foremost importance.

Characteristics are:

Heater Voltage.....	6.3	6.3	volts
Heater Current.....	.15	.15	amp.
Plate Voltage.....	135	180	volts
Screen Voltage.....	135	180	volts
Grid Voltage.....	-6	-9	volts
Plate Current.....	11.5	15	ma.
Screen Current.....	2	2.5	ma.
Plate Resistance.....	170,000	175,000	ohms.
Amp. Factor.....	360	400
Load Resistance.....	12,000	10,000	ohms
Power Output.....	.6	1.1	watts
Total Harmonic Dist.....	7.5	10	per cent
Self Bias Resistor.....	440	510	ohms

Flexible Concentric Line

A new type of flexible concentric cable with high insulating qualities has been devised by Transducer Corp. Construction of the line is much similar to the standard rigid variety, namely, an

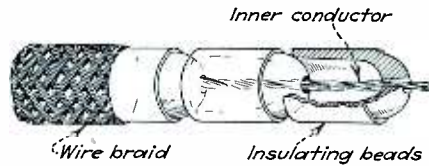

outer conductor insulated from the inner conductor by beads. The difference in the new line is in the outer conductor. A flexible, close-woven braid is spun over the insulating beads.

As illustrated, the line is packed solid with beads. These are nested, one against the other, so that the line may be bent in a rather small radius. The inner conductor is a solid wire

A new plastic material called "Anhydron" is used in the construction of the beads. It is light in weight and possesses electrical characteristics comparable to quartz. The breakdown voltage of this material is 1,250 kv. per inch.

In addition to use as transmission lines for antennas the line may be used for photo-electric and amplifier cables.

Computing Condenser Breakdown

The flash-over voltage value of transmitting condensers is given in the following chart by Cardwell. Values given are for air condensers with polished plates and rounded edges. Data are shown for operation on 60 cycles, 515 kc. and 4000 kc. All calculations for high frequency operation should be made on the 4000 kc. line.

To use the chart it is first necessary

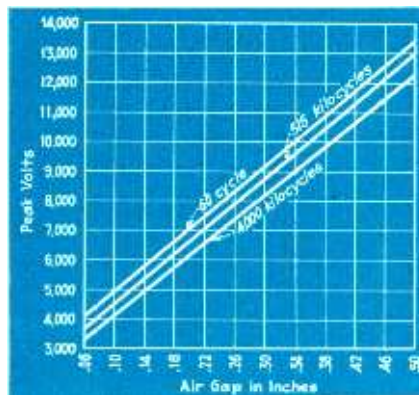

to find the peak volts developed in the tank circuit. This can be computed fairly accurately by multiplying the plate voltage of the tube by 3 for telegraphy transmitters. If the tube is plate modulated multiply plate voltage by 4 to find peak volts. The result obtained should be found on the left vertical column. Follow this point across to where it intersects the 4000 kc. line then down horizontally will give the condenser spacing in inches. This spacing is measured from the outside of one plate to the nearest plate. Thin plates require a breakdown of 8 per cent or more. Square edge plates require about 20 per cent more spacing.

Transmitting Beam Pentode

814—Filament type beam power transmitting pentode by RCA. Maximum output 130 watts up to 30 mc. Medium 5 prong ceramic base. Overall length 7 7/8 in.

Class C Telephony Characteristics

Filament Voltage.....	10	volts
Filament Current.....	3.25	amps
Plate Voltage.....	900	1000 volts
Screen Voltage.....	300	300 volts
Grid Voltage.....	150	150 volts
Plate Current.....	120	120 ma.
Screen Current.....	15	17.5 ma.
Grid Current.....	10	10 ma.
Screen Resistor.....	40,000	40,000 ohms
Grid Resistor.....	15,000	15,000 ohms
Driving Power.....	2	2 watts
Power Output.....	76	87 watts
Capacity, grid to plate (with external shield).....	.1	mmf
Input Capacity.....	13.5	mmf
Output Capacity.....	13.5	mmf

Class C Telegraphy

Plate Voltage.....	1000	1250	volts
Screen Voltage.....	300	300	volts
Grid Voltage.....	-70	-80	volts
Plate Current.....	150	144	ma.
Screen Current.....	17.5	22.5	ma.
Grid Current.....	10	10	ma.
Screen Resistor.....	40,000	42,000	ohms
Grid Resistor.....	7,000	8,000	ohms
Driving Power.....	1.35	1.5	watts
Power Output.....	100	135	watts

Lowering the Crystal Frequency

When a quartz crystal has been ground thinner than desired the frequency can be again lowered by the following method outlined by Stancor. Coat the crystal on both sides with India drawing ink, using a small brush. The frequency can be decreased from 14 to 28 kc. on a 40 meter crystal.

Permit the crystal to dry thoroughly before using. Carefully check the crystal frequency before putting it on the air

EVERY radio service man often encounters the radio that cuts off and on. There appears to be nothing wrong with the set except that it won't operate at the customer's home and plays perfectly on the work bench.

These sets are not confined to any particular make or type as it seems to be an ailment that any radio may have. So, no effort will be made to delve in the peculiarities of any particular model or type of set.

Since service work to be profitable must be done as quickly and efficiently as possible it behooves the service man to tackle the set that cuts off and on in such a manner to find the trouble with a minimum of time.

Quiz the Owner

The first analysis is to question the owner just as thoroughly as possible as to how the trouble occurs and as to what he does to the set to get it to start playing again. If it is a battery set and the owner says it starts alright, then quits in a few minutes, then it is a dead give-a-way that the "A" battery is failing. But on the other hand if it is a standard AC type house set, and turning a house light off and on causes the erratic operation, the trouble may also be localized to a bad condenser or volume control, or some other obscure trouble (anything that a slight surge of voltage would affect). An intelligent quiz will often tell the service man where to look for the trouble.

On the work bench two types of sets will be encountered, those that are intermittent and those that are inoperative. The last type is the one that gives the real trouble, but both types can be serviced in much the same way. The first step is to eliminate the tubes as a source of trouble, the easiest way to do this is temporarily substitute a whole new set.

Next a good heavy rubber handled screw driver used as a hammer and pry bar is a good tool with which to jar component parts to see if there are any loose connections or cold solder joints. A goodly number of the cutting off radios will yield to this simple treatment.

Where first efforts are of no avail the next step would be to try to localize the trouble. Some method of measuring stage gain and taking the signal out at desired points would be the logical apparatus to use. The writer uses most of all a signal generator operated at low level and an oscillograph as an output indicator. The signal is fed in starting at the aerial and moved up stage by stage through the detector into the audio and finally out to the speaker; changing the frequency of the generator in accordance with each stage. Where the trouble making stage can be located it is checked as thoroughly as possible, if the trouble can't be found the condensers and resistors are all changed for that particular stage.



Service Methods for Intermittent Sets

By C. L. SMITH

If the set is of an older type, probably the first thing to try would be to see if there were any bad or corroded coils or transformers. For this particular type of testing there is nothing that can beat a good high voltage current of about 350 volts and a hundred milliamps or so in strength. This much current will put out of commission a corroded coil, leaky condenser or bad resistor but will not damage a good part. It is applied with test prods to all suspicious parts and in a great number of cases will show up the trouble very quickly.

In regards to this high voltage test, there may be some argument as to its use. The argument will be that it might ruin good parts. From experience it won't damage any coil, transformer or resistor if used sparingly; if a resistor or condenser is so near to the danger point that it can't take the current, then swapping it at this time will probably just save a come-back free service job anyway.

Listen for Characteristic Noises

So far all efforts at locating intermittent types of trouble have been aimed at locating mechanical looseness or weakness in the set. It happens that intermittent troubles are not always localized to mechanical troubles but in some cases are of a pure electrical type. Experience is the best teacher here, a good ear for spurious sounds often tells the trouble. Open grids cause their own peculiar type of noise and leaky condensers do make a set sound like a motorboat. In the same respect almost any failure of any particular part will give its own peculiar type of sound to the operation of the set. If the trouble

is obstinate a little judicious unsoldering of certain parts and listening to the result may shed some light on what is really happening when the set goes dead.

For the set that will not perform right at the customer's home but does fine at the shop it is suggested that there is some difference in the operating conditions. It may be found that the line voltage is high or low. An auto-type transformer or some type of rheostat to make the shop voltage similar to the house voltage will oftentimes help to make the set cut-off at the shop also.

It has been proven that it is pretty much a waste of time to haphazardly change condensers, coils or resistors, or to otherwise get stage fright when an obstinate set comes into the shop. If at all possible the trouble should be listened to and used as a guide in service procedure. A routine check as already outlined will in nine cases out of ten throw particular light on the subject.

In this particular territory some trouble is encountered through oscillator systems that fail to oscillate. This is caused by one of three things; coil moisture, bad tubes, and resistors that have changed in value. Where the trouble is intermittent it will also be found combined with a varying voltage at the customer's home. A little juggling of cathode and plate resistors and a bit of coil insulating will be the remedy.

Auto Radio Antics

Auto radios are in a class by themselves but, except for one exception they are treated as any other type of radio
(Continued on page 74)

THE

Standout value

FOR '38

THE WESTON

Model 772
Super-Sensitive
Analyzer

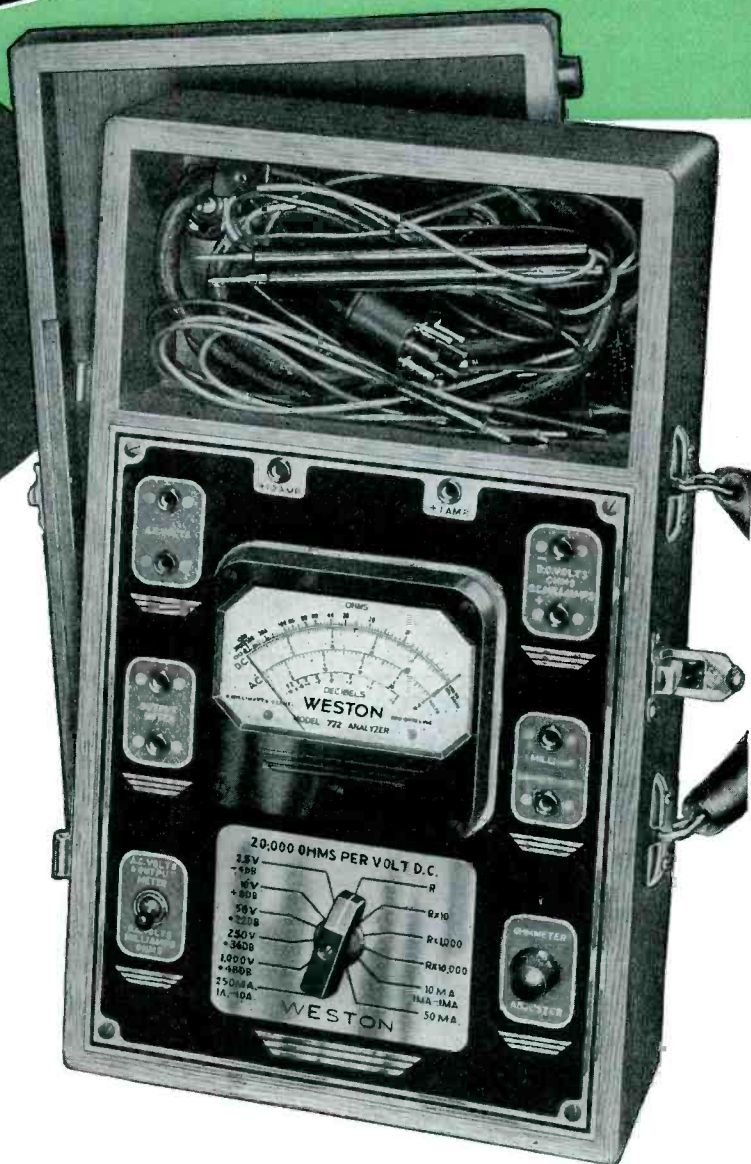

WITH THESE ADDED FEATURES AND REFINEMENTS!

- ★ Simplified, easy-reading scale, AC readings on single AC arc
- ★ Decibel readings for sound measurement
- ★ Current ranges for auto testing
- ★ New, improved rectifier circuit . . . accuracy (WESTON guaranteed) 3% on normal frequencies
- ★ Temperature error (WESTON guaranteed) within 2° from 40°F to 110°F
- ★ 20,000 ohms-per-volt . . . big, dependable, 50 microampere WESTON Meter
- ★ Broad ranges to meet every requirement testing receivers, transmitters, television, vacuum tube and cathode ray equipment, sensitive relay circuits, etc.
- ★ Sound engineering . . . expert craftsmanship . . . highest quality parts . . . dependability for years.

Resolve, now, to start the year right with *dependable* test equipment . . . the kind of equipment that *remains* dependable and *stays* serviceable throughout the years. It will save you time and annoyance, save you money, and put more profits in your pocket. When you buy an analyzer, for example, be sure it's the WESTON 772, for no other analyzer can give you equal dependability

and lasting service. For no other analyzer has a proved WESTON Meter . . . resistors of equal precision and stability . . . perfected WESTON silver contact switches, and other materials and parts of WESTON's high quality standards. Start the year right . . . and end it with more profit . . . with WESTON 772 and other test equipment. Send the coupon for complete information.

WESTON

Radio Instruments

Weston Electrical Instrument Corporation
581 Frelinghuysen Avenue, Newark, N. J.
Send complete information on WESTON Radio Instruments.

NAME.....
ADDRESS.....
CITY..... STATE.....

SHORTCUTS

Aligning Avc Receivers

By Boris S. Naimark

Most modern sets employ some form of avc. Most servicemen employ an output meter for the accurate alignment of such avc receivers.

It is obvious that efficient avc action defeats the very purpose for which the output meter is employed so that the latter will not faithfully indicate changes in output during the several r-f, i-f, and oscillator adjustments; the extent to which this is true depending upon the type of the avc circuit employed, and upon the efficiency of the avc action.

Fortunately many receivers employ some form of resonance indicator. These resonance indicators—"magic eye," tuning meter, "shadow-graph" or reactance dimmer—are commonly connected



COMPACT SHOP—Test equipment, files, library and tools; all within easy reach of Frank S. Williams, Williams Radio Co., Paris, Ill. for a quick repair job.

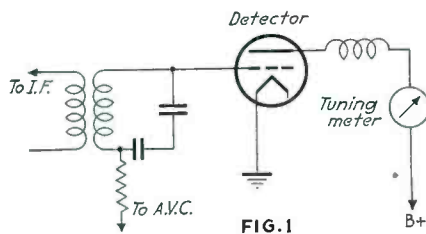

FIG. 1

in the r-f section of the receivers in such a manner as to be independent of the audio output levels.

In such receivers it is advisable to dispense with the aid of the conventional output meter, and to employ the resonance indicator itself as the output indicator, thus freeing our adjustments from the "cross-purpose" action of the avc.

Many receivers, however, while em-

ploying avc do not incorporate a resonance indicator. In such receivers, if it is suspected that the avc action may sufficiently interfere with the output

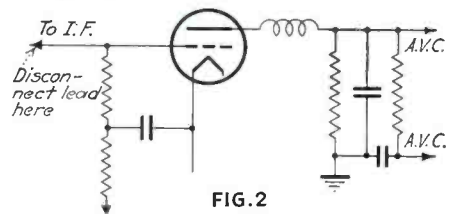

FIG. 2

meter in obtaining accurate alignment results, it is simple again to dispense with the aid of the output meter and to connect temporarily or permanently a tuning meter in the plate circuit of one or more tubes under avc control. Fig. 1 illustrates this.

If this proves impractical or impossible for one of many plausible reasons some method must be employed to prevent the action of the avc entirely or to reduce its effectiveness to a point where its output leveling action will not interfere with the output meter, connected in

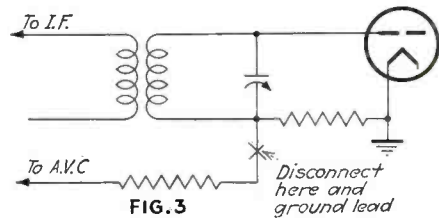

FIG. 3

the conventional manner in the output portion of the receiver being aligned.

The following 5 methods have been found satisfactory and are recommended.

1. In *delayed avc* systems simply reduce the output of the signal generator to a point so low that avc action does not take place.

2. In systems employing a separate tube for the avc function disconnect the

(Continued on page 74)

Only C-B Frequency Modulator Has SINGLE-SIGNAL

QUALITY
STANDARD
OF THE
RADIO
INDUSTRY

NO FREQUENCY modulator other than the C-B Model 111 delivers only the wanted signal. To achieve this all-important, time-saving result, five tubes are used instead of three in other types, and they're not ballast tubes, either. Only exclusive C-B construction guarantees you're actually working at desired frequency, and not in the dark. Costs more. **\$3950** Worth it many times over.

FREE
VISUAL
SERVICE
COURSE
WITH
ANY
C-B UNIT.
ASK
YOUR
JOBBER.

NEVER BEFORE offered at this low price, the CRA oscillograph is the same super-dependable, precision instrument that so long has led the field. Nothing cheapened, nothing left out. Unequaled sensitivity, coupled with a multitude of exclusive engineering refinements and operating features, assures performance standards that have never been approached. A true laboratory instrument now priced **\$6450** within everyone's reach.

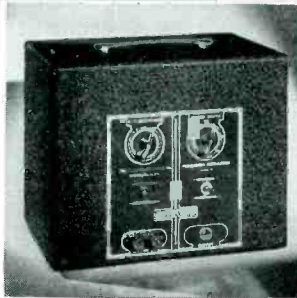

EASY MONTHLY TERMS!
C-B instruments pay their own way. Ask your jobber.



The CLOUGH-BRENGLE CO.

2819 W. 19th St.

Chicago, Ill.

HARD NUTS EASY TO CRACK

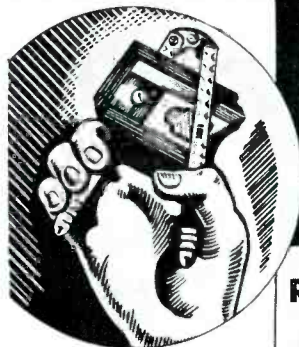

Operations Peculiar to
New and Complicated
1938 Sets Easily Under-
stood if you have _____

RIDER MANUAL VOLUME VIII

Because it is so complete—because it explains many of the operations peculiar to the new sets—because it contains everything given us by more than 100 manufacturers—Volume VIII is the biggest Rider Manual yet issued. 1650 pages give you what you want—arranged as you want it. Order it—and any of the other seven volumes you need—today! The eight volumes now contain 9620 pages of material you need!

1650
PAGES
\$10.00



—and here's a
RIDER BOOK
explaining
**AUTOMATIC
FREQUENCY
CONTROL**

With AFC circuits in most higher priced models, knowledge of "AFC" means money in your pocket. Learn the practical facts from these easily understood explanations. Hard covers, 144 pages, \$1.00.

JOHN F. RIDER, PUBLISHER
1440 Broadway, New York, N. Y.

Remember **YOU NEED ALL 8**
Rider **MANUALS**

REMEMBER GIRLS. HE'S HERE TO FIX THE RADIO



The radio service man must do his work quickly and do it right if he is going to make money and build a list of satisfied customers. The use of dependable replacement parts that do not fail are a big help. That is why so many successful service men are using the parts described in bulletin 507.

WARD LEONARD ELECTRIC COMPANY

35 South Street, Mount Vernon, N. Y.

Please send me your Service Man's Bulletin No. 507.

Name

Address

City State

Jobber's Name

RADIO RETAILING, JANUARY, 1938

No Transformer Troubles Now... JEFFERSONS withstand our climate successfully... says

Mr. G. A. Gitz
New Orleans

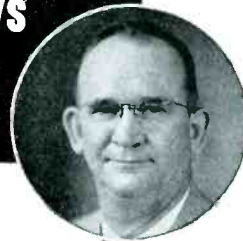

GITZ APPLIANCE COMPANY
G. A. GITZ - AL. MAYEUR
REFRIGERATORS - WASHERS - RADIOS
3321 SO. CLAIBORNE AVE.
NEW ORLEANS, LA.
November 9, 1937

Mr. Wiltz Le Boeuf,
Jefferson Electric Company,
Bellwood, Illinois.

Dear Mr. Le Boeuf:

I have been using Jefferson Transformers for about one year and a half. In our humid climate we experienced a great deal of trouble with transformers of all types, but the first Jefferson Transformers that were used by me are still giving satisfactory service, and this is the reason that I used Jeffersons on the expensive installation illustrated below.

Mr. William G. Zetzmann, president of the Zetz 7 Up Bottling Company has personally complimented me on the tone of the 60-watt amplifier built for them. If it were not for the fact that I used higrade transformers, I would not have received this and many other compliments.

Yours very truly,
G. A. Gitz
G. A. Gitz

Views of 60-watt amplifier built by Mr. Gitz, which has three dynamic microphones, radio, phonograph, electric organ and chimes, all electronically mixed—and with remote control to the broadcasting stations.

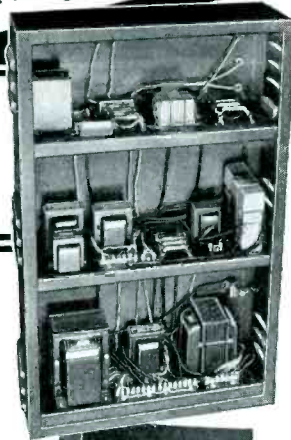

You, too, can make sure of the best results—clear tone and long service by using the transformers that builders of the finest systems and transmitters use—Jefferson Transformers. When ordering from your jobber, specify them by name. Write for the 1938 Radio Catalog and Manual of latest Amplifier Circuit Diagrams. JEFFERSON ELECTRIC COMPANY, Bellwood (Suburb of Chicago), Illinois. Canadian Factory: 535 College St., Toronto, Ont.



JEFFERSON

Radio Transformers

ARCTURUS

Radio's finest tubes plus radio's fairest equipment deal spell double profit to you.

Mail the Coupon!

- If you need new service or shop testing equipment...
- If you want to get it at almost no cost to yourself...
- If you are interested in the fairest, easiest Equipment Deal in the history of radio...
- ...Then you owe it to yourself to get the facts without delay. Let Arcturus help you modernize!

ARCTURUS RADIO TUBE CO.
Newark, N. J.

Without cost or obligation on my part, send details of your new equipment deal.

Name _____
Street _____
City _____ State _____ R-3

I am a dealer I am a serviceman

My Jobber is _____
For your convenience, this coupon can be posted on a penny postcard.

SHORTCUTS

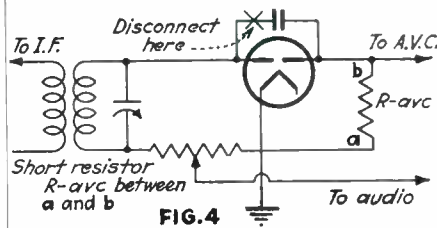

lead which feeds the control grid of the avc tube. (Fig. 2.)

3. Where feasible, disconnect the grid return lead of the avc controlled tubes from the avc feed point and ground. (Fig. 3.)

4. In diode type avc circuits in which the two plates are not tied and where separate resistors are employed to develop the audio and avc voltages respectively it is recommended to short resistor R-avc or bridge it with another resistor approximately one-tenth the ohmic value of R-avc. (Fig. 4.)

5. In diode type avc circuits where the avc diode plate is coupled to the detector diode plate by means of coupling condenser C, disconnect one end of this coupling condenser, this removes avc signal.

The above methods have all been given a trial and have aided materially in obtaining more accurate alignment of critical circuits. Needless to add, the alignment procedure completed, the circuits must be restored to their original condition.

Increasing Battery Life

By Gerald Evans

Battery life on 6 volt power plants is considerably shortened if proper care is not exercised in charging and discharging. Holding the charge rate down for long battery life and the efficiency up is a large order.

It is advisable to always keep the battery fully charged, and to charge at a slow rate. The generator should be started every evening about dark, and enough fuel put in the tank to run for a few hours after the load has been removed, providing the load does not exceed the generator output. In that case the time of additional charge will be longer.

Batteries should not be charged in the daytime when there will be no load, unless the battery is nearly discharged. Charging the battery slowly (about 2 amps.) after it has passed the halfway mark will add months to its life.

Most plants are equipped with two high amperage batteries. It usually is

better to use four smaller batteries as a higher charge rate is possible. The small batteries have a better chance to remain cool while charging.

Testing Audio Coupling Condensers

By E. S. Adamson

Considerable trouble is often encountered with leaky audio coupling condensers. Yet, even when one is suspected it is difficult to test them without a high-range ohmmeter.

A simple check is to remove the grid end of the condenser from the circuit. This leaves the other end connected to B+ through the plate resistor of the previous stage. Testing from the open end of the condenser to ground with a low current voltmeter will give a fair indication of the condenser leakage. A 300 volt meter scale is satisfactory. Using a lower scale will give greater accuracy. If any continuous reading is obtained, replace the condenser.

SERVICING INTERMITTENTS

(Continued from page 70)

which goes dead periodically. This one exception is that greatest cause of intermittent operation of car radios; a bad vibrator. The owner will generally give this trouble away by the way he tells you how the set performs—viz.: "My radio has a loose connection in it, won't you come out to the car and tighten it up. Sometimes it will play and sometimes it won't. Yesterday I turned it on and forgot all about it and when I hit a bump it started to play." In all such cases just try to sell a new vibrator or better still tell him yes you know just which connection is loose and take the radio off of the car and then tell him about the vibrator.

Then there is another little trick that sometimes works wonders. It is as simple as it is efficient. It is to take a hot soldering iron and go over all the solder joints in the whole set; this especially applies where a set is old and a good deal of service work has already been done on it by other service men.

In some of the most obstinate cases it will not hurt to use artificial heat or cold to change the operating temperature of the set. But, in the great majority of cases the methods already outlined will help to locate the trouble.

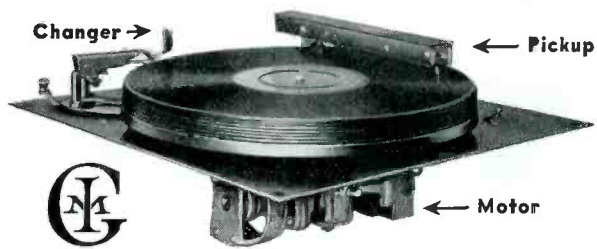

30 Million Records a Challenge To You

INDUSTRY sales figures show that 30 million phonograph records were sold in 1937; a larger sale is anticipated in 1938. Dependable yet low-cost record changers are largely responsible for this greatly enlarged demand. Make it your business—and it's profitable business, too—to sell your share of phonographs and combinations that are equipped with a General Industries record changer unit. They come ready-assembled for easy installation with low labor cost. Complete with silent, smooth-running Flyer Motor and turntable; latest flat-type, flexible, balanced pickup; improved, simple and accurate changing mechanism.

Order Samples For Testing

Latest improved Model M plays and changes eight 10" or seven 12" records. Model K plays and changes seven 10" records, plays 12" records changed by hand. When ordering samples please specify exact voltage and frequency of current you use.

The GENERAL INDUSTRIES CO. 3837 Taylor Street,
Elyria, Ohio

Millions in Use—They do the work

THE *Eyes* HAVE IT!

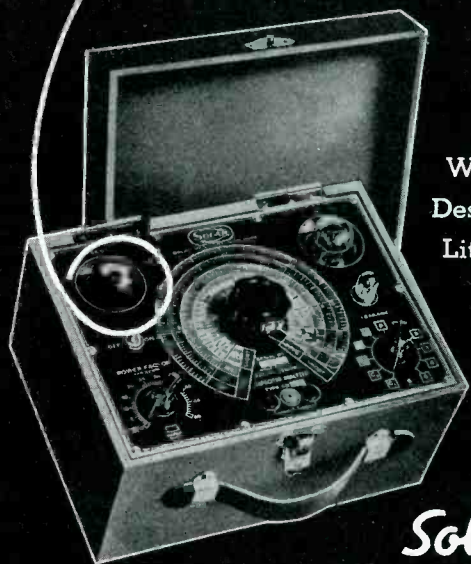

Write for
Descriptive
Literature

*Solar
Capacitor
Analyzer*

Your eyes and the MAGIC TUBE...
see all, know all, quick as a wink!

SOLAR MFG. CORP.

599-601 Broadway New York, N. Y.



**NO HUM
NO BUZZ
TRANSFORMERS**

• • • WILL MAKE YOUR STORE
**TRANSFORMER
HEADQUARTERS**



There's no feed-back from UTAH output transformers in a Class B circuit. Every coil in every UTAH transformer is uniformly wound and carefully and completely impregnated. Unusually high safety factors in both design and insulation prolong transformer life and increase efficiency.

Not all radio men know why UTAH transformers act better, but they do know from actual experience that UTAH transformers don't talk back. And they also know they can always get what they want from UTAH, because the line is complete.

There's an easy way to make your store the reliable source for replacement transformers. Just standardize on UTAH! It's the profitable thing to do. Address Dept. RR-1 for complete details.

Stock UTAH Parts

For Greater Profits

- | | |
|-------------------|------------------------|
| V Speakers | V Resistors |
| V Transformers | V Plugs |
| V Chokes | V Jacks |
| V Volume Controls | V Jack Switches |
| V Tone Controls | V Push-Button Switches |
| V Vibrators | V Control Motors |

UTAH RADIO PRODUCTS CO.
CHICAGO, U. S. A.

TORONTO BUENOS AIRES
ONTARIO, CANADA (UCOA RADIO PRODUCTS CO.)

"16 YEARS OF LEADERSHIP"

TRICKS

AIRLINE 40

Intermittent . . . open half megohm resistor in plate circuit of 24 avc tube. Replace with new unit.

AIRLINE 62-177

Dead . . . check for shorted .01 mfd. coupling condenser between 6B7 plate and 6F6 grid.

Loud volume with double hump resonance curve . . . replace 300,000 ohm resistor between screen grid of 6F6 and 6B7 tube.

CROSLEY 635

Oscillation or dead . . . check condenser 17B in schematic connected between cathode and screen of 6A7.

G. E. E71

Dead . . . check second i.f. plate bypass condenser (.02 mfd) for short. Also check 2200 ohm plate dropping resistor by removing second i.f. coil shield.

No volume . . . replace 2200 ohm second i.f. cathode resistor.

G. E. 76

Dead on broadcast band . . . shorted .01 mfd 200 volt condenser connected to shaft of all-wave switch by green wire. Replace with 600 volt condenser.

G. E. K-64

Motorboating and cutting out . . . replace 600 ohm first r.f. bias resistor. Oscillation . . . Check double 4 mfd. electrolytic.

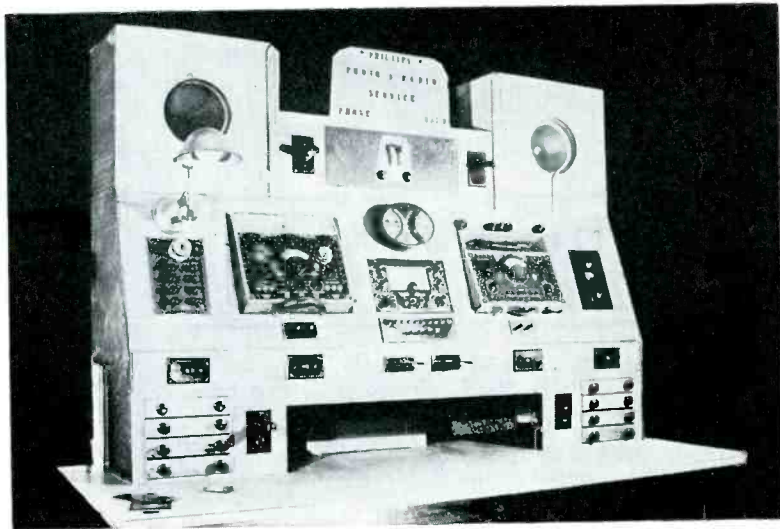

DESIGN FOR SERVICE—Modern, efficient layout at Phillips Photo-Radio Service, Mt. Vernon, Ohio. Dual set of pull-out test leads (Bottom center) make this a two man bench. Instruments are the standard portable types, may be removed when necessary.

HEADLINE NEWS FOR 1938

JANUARY

ST. PAUL, MINNESOTA

ATR SMASHES VIBRATOR PRICES

DRASTIC PRICE REDUCTIONS EFFECTIVE IMMEDIATELY ON COMPLETE ATR REPLACEMENT VIBRATOR LINE

Examples of ATR price reductions:

ATR Vibrator	FORMER List Price	PRESENT List Price
303	\$3.50	\$2.50
324	4.00	2.75
326	4.50	2.90
521	5.00	3.75
536	5.25	3.95

New prices subject to normal discounts.

ATR Replacement Vibrators set new high standards of performance and construction. Greater life and reliability made

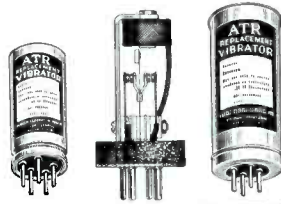

possible by new designs utilizing 3/16" diameter tungsten contacts.

ATR Vibrators are proven units of the highest quality, engineered to perfection. They are backed by more than seven years of vibrator design and research, development and manufacturing

—ATR pioneered in the vibrator field.

FREE—Win an ATR Auto Radio "A" ELIMINATOR on special introductory ATR vibrator deal. Full details sent on request.

Insist on ATR VIBRATORS, the Best by Test.

Write for your **FREE** copy of the new 1938 ATR Vibrator Guide and Name of your Nearest ATR Vibrator Distributor

AMERICAN TELEVISION & RADIO CO.
128 East Tenth St. St. Paul, Minnesota

NEW UNIVERSAL DYNAMIC MICROPHONE

100% Satisfaction or 100% Refund

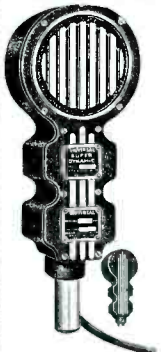

List \$14.50 with 25 ft. cable

Self energizing. Not affected by heat or climate. An amazing sound development. Impedances 33 or 50 or 200 or 500 ohms; also high impedance direct to grid. Frequency response 40-8000 C. P. S. Output —58 db.

Microphone Division

UNIVERSAL MICROPHONE CO. LTD.
Box 299 Inglewood, Calif., U.S.A.



Licensed by A.A.&K., produced with typical CORWICO attention to scientific detail. Warranted to banish man-made static on broadcast as well as shortwave frequencies. Write for information regarding this and other CORWICO units. . . .
MADE BY ENGINEERS FOR ENGINEERS

CORNISH WIRE CO., Inc. 30 Church Street New York City

CHECK

STANCOR

QUALITY

Any way you wish . . . you can check Stancor and the answer is always the same—"It's quality that counts."

Sometimes Stancors cost a few cents more than other transformers of the same characteristics . . . BUT THEY'RE WORTH IT.

NOTE
CHECK THESE POINTS
AGAINST THE FIELD .

1. Cores of highest grade, laminated silicon steel. ✓
2. Windings checked after each operation. ✓
3. Positive vacuum - impregnation with special equipment. ✓
4. Triple Tested on dummy loads for perfect performance. ✓
5. The most modern factory in the industry. ✓
6. Finest appearance. Newest finishes, embossed name-plates, concealed connections. ✓

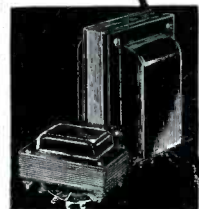

Then You'll
BUY
STANCOR

STANDARD TRANSFORMER CORPORATION

850 BLACKHAWK STREET • CHICAGO

YOU'RE SURE OF YOUR PROFITS



UNDER THE TUNG-SOL CONSIGNMENT PLAN

You don't buy Tung-Sol Tubes, and then wait until they're sold to get back your investment. They're put in your custody without payment. After they move, you report your sales, pay at your cost price and keep the profit. No cash investment—no dead stocks. And our ability to finance is extended to you without any premium whatsoever.

It's a straightforward, simple, business proposition by a concern financially able and willing to give this co-operation to dealers who can qualify for the Tung-Sol franchise. Naturally, Tung-Sol dealers must be responsible, ethical business getters.

Write today. Perhaps you can qualify for a Tung-Sol Consignment franchise in your neighborhood

TUNG-SOL

Tone-flow Radio Tubes

TUNG-SOL LAMP WORKS, INC.

Dept. B Radio Tube Division

SALES OFFICES: Atlanta • Boston • Chicago
Dallas • Kansas City • Los Angeles • Detroit
New York • General Offices, Newark, N. J.



**TO GET MORE
BUSINESS...**

Sell Something
NEW



THAT'S the slogan of dealers who are in the money today. That's why leading dealers all over the country are featuring the **PRESTO JR. SOUND RECORDER**. Because it's new. Because everyone likes to talk into a microphone. Because everyone likes to hear his own voice reproduced from a phonograph record.

THE PRESTO JR. RECORDER will bring more customers into your store . . . make more friends for you . . . give you more word of mouth advertising than anything else in your line.

WRITE TODAY FOR THE NEW PRESTO FOLDER ENTITLED "HOW TO SELL THE PRESTO SOUND RECORDER." It tells you step by step how successful dealers have developed the market for recorders. It illustrates free window and store display material, ready to run ads for your local newspaper and direct mail pieces.

**PRESTO
RECORDING CORP.**
143 W. 19th St., New York, N. Y.

TRICKS

PHILCO 14, 91

Volume control noisy, installing a new control only temporary cure . . . Disconnect the end of the control that goes to the detector and from this detector lead connect a 300,000 ohm. $\frac{1}{2}$ watt resistor to ground as shown in the diagram. Also from this lead bridge a .06 mfd condenser to the disconnected end of the volume control. This removes the d.c. from the control and permits quiet operation.

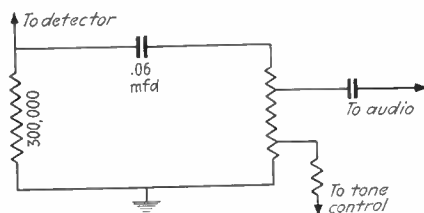

RCA 80

Poor tone . . . the 110,000 ohm resistor connected from the i.f. plate to second detector cathode has decreased in value affecting the bias on the latter tube. Replace with 5 watt resistor.

VICTOR RE 45 PHONO

Low Volume . . . adjust pickup magnets as close as possible by squeezing with pliers. Adjust armature. If rubbers have hardened, replace.

RCA 9T, 9K2

Poor reception on broadcast band, O.K. on short waves . . . replace screen resistor on 6L7.

SILVERTONE 1310, 1312, 1330 COLONIAL 37, 37P

Distorted, unstable, weak or dead . . . common fault of these receivers is leaky or shorted bypass condensers.

SILVERTONE 1760

No reception look for shorted 1 mfd. condenser bypassing second i.f. plate supply. Usually the 1000 ohm resistor in same circuit needs replacing.

SIMPLEX 5DA

Static, noisy . . . check oscillator coil. Replace coil to eliminate trouble.

STROMBERG CARLSON 38

Weak, station hiss which disappears when the grid of the 58 r.f. tube is touched . . . primary of preselector coil grounded to metal braid of antenna post.

PRECISION APPARATUS CORP.

CORRECTION

Page 69 December Radio Retailing. Line of type under Series 700 belonged under advertisement of Series 840-L. This advertisement described model 840-L. Photo shown is type 840-P. Net price \$21.95.

Champions
HAVE SOMETHING
EXTRA



A FORWARD pass right down the middle — the receiver gathers it in — he's away—and over for a touchdown!

It's that "something extra" that makes the pass click — **CHAMPION** Radio Tubes have that "something extra"—both in Quality and dependable service — and pass to the jobber and dealer those extra PROFITS.

For information write

CHAMPION RADIO WORKS
Danvers, Mass.

Champion
radio tubes



★Division Consolidated Electric Lamp Co.
★Makers of Champion Lamp Bulbs

TRICKS

ADMIRAL AM 787, AM 488

Dial drive belt slips off guide pulleys . . . remove flywheel from shaft, tin exposed sides of guide pulleys, solder $\frac{3}{4}$ in. washer to each side of pulleys. Washer is made from 1/32 in. copper or brass with $\frac{1}{4}$ in. hole drilled in center.

CROSLEY 178

No control of volume . . . shorted condenser from filament of 32 tube.

G.E. A63, A65

Distortion and low volume . . . shorted or leaky .03 tone control condenser.

G.E. A87

Weak or dead . . . check for shorted .05 condenser and charred 2000 ohm resistor inside second i.f. can.

PHILCO 90, 90A

No reception. . . . 27 oscillator periodically goes dead despite normal circuit conditions.

RCA VICTOR R8

Rubber ring on dial drive assembly slips on shaft . . . make thin metal washer the size of the rubber ring. Slip washer over shaft and hold in place by a small pin through shaft and soldered to washer. Then pin ring to washer.

SPARTON 69

Weak or no reception . . . trace leads connecting low ends of r.f. chokes to condenser block. Disconnect leads from block and test for continuity from the now vacant lug to chassis. A reading indicates this section shorted. Replace with a 125 mfd. 400 volt unit.

STEWART-WARNER 1845 TO 1869

Motor hums but does not run . . . reversing contacts on back switch not closing; low line voltage or improper line frequency.

Intermittent operation of motor and lights . . . insufficient contact pressure or dirty contacts on back or side switch. Set tunes broadly . . . afc contacts on side switch not closing.

Slight hum when button is depressed, not heard when button is released . . .

poor or defective discriminator tube.

Signals are heard when tuning from one station to another automatically . . . muting contact back switch not closing or making poor contact.

Set noisy electrically when starting and stopping during automatic tuning . . . insufficient antenna or mute contacts on back switch closing too late and opening too soon.

ZENITH 5M191

Intermittent when car is in motion, noisy, poor quality, jarring the set will cure the trouble for a short time . . . tuning cable is inserted too far into condenser coupling. The result causes the condenser to be held solid instead of resting on the rubber mounting washers. Also check the antenna connectors for noise.

ZENITH 1937 6 AND 8 TUBE MODELS

Low sensitivity and volume, broad tuning . . . increased resistance in primary windings of i.f. transformers. Resistance varies from the normal 6 ohm to as high as 90 or 3000 ohms. Replace all i.f. transformers for permanent repair.

Advertising in RADIO RETAILING gets Results

In the November issue of Radio Retailing the Indian Products Corp. of Chicago announced a new line of self-contained air conditioning units under the name, Koolroom. Aside from the innovation of a complete air conditioner self contained in a beautifully finished metal cabinet all ready to plug in, the added feature was the low price range for a line that ranged from a 1/3 h.p. air cooled window sill job to a 1 1/2 h.p. console type, respectively.

Just how effective this announcement was, is shown by the flood of pleas for franchises that practically overwhelmed Koolroom's sales offices as a result of this one advertisement in Radio Retailing. Several inquiries were received from far away Switzerland, which is further proof of Radio Retailing's wide coverage and pulling power.

IT PAYS
TO ADVERTISE IN **RADIO RETAILING**



● There's ample reason why CLAROSTAT Controls are outstandingly QUIET. The one-piece sliding contact with proper pressure and correct choice of alloy; an entirely NEW composition element; positive conduction throughout; smooth resistance changes in tapers—these features spell QUIET.

You're the Judge!

Put today's CLAROSTAT Control on trial. Even give it the third degree. Then write your own verdict. Meanwhile, be sure you have our new pocket-sized (208-page) Service Manual in your working library. Free for the asking!

CLAROSTAT Manufacturing Co., Inc.

285-287 NORTH SIXTH STREET
BROOKLYN, NEW YORK, U.S.A.

• OFFICES IN PRINCIPAL CITIES •

DO WE NEED A NATIONAL ASSOCIATION?

(Continued from page 19)

established retailers and their sales. A separate section fitted into the proposed national organization would provide a very desirable method of giving that service branch of the industry means of national expression within a background that would insure proper cooperation with other branches of the industry.

It is also conceivable that many wholesale distributors might wish to join, in which event another separate section could be created.

Furthermore, the plan of organization would have to be such that aside from fullest cooperation between the various autonomous groups or sections, complete and unrestricted freedom be assured to members of the trade who wish to join as individuals because they do not belong to any one of the affiliated groups.

Finally it would be of prime importance to have the basic set-up of the organization provide for a thoroughly representative form of government which would give each group

or section a voice in the affairs of the national association with its voting power based on its proportion of membership.

Important Objectives Outlined

While it is impossible to mention within the confines of this article all the factors that will require consideration if a national association is to be created some of the most important ones now have been discussed.

As to the benefits that may be derived from membership in and support of a national association, much depends upon how well its fundamental set-up was planned, how representative it is, how much interest its members are taking, how many real workers it attracts, how well it is financed and how well its affairs are managed.

Naturally the most important sphere of activity for any national association is in connection with these problems of the trade that are national in character.

Thus for instance a national organization would command attention in case the federal government should attempt to impose excessively high taxes, on radios, appliances, etc.,

flooded with cheap imported and generally inferior, often even dangerous products, the protestation of a strong and representative national group will get action more quickly than if individual dealers from here and there voiced complaints.

With such an organization active in the field it is conceivable that the Miller-Tydings Act may have contained some provisions that would have solved or at least alleviated the situation in the radio and allied trades where at present dishonest dealers can easily get around fair trade contracts by simply using the trade-in allowance route to price cutting.

Naturally the staff of the organization also would be alert to proposed new laws, or ordinances, no matter where introduced, and would organize effective opposition or support as the case may demand.

Such national evils as "wholesale" buying by retail consumers or group purchasers could be dealt with. Certainly there is great need for cooperative action that will improve the mer- and could exert an important influence in having existing special taxes repealed or reduced.

In cases where the market is



Model 430
DEALER
Price
ONLY
\$19.80

Judged by the number in use ..
TODAY'S MOST POPULAR TUBE TESTER

- Has Line Voltage Adjustment
- Has Leakage and Short Test
- Uses Triplett Direct Reading Instrument (GOOD-BAD) Scale

Readrite

Positively Checks All Type Radio Tubes According to Latest Recommendations of Tube Engineers. Five flush type sockets provide for all tubes. The tester operation is very simple and indicates condition of the tube for dealer and customer on Direct Reading (GOOD-BAD) colored scale of Triplett instrument. Will also test for inter-element shorts and leakages. Complete in attractive, sturdy, quartered-oak case. Sloping etched panel of silver and black. Suitable for portable or counter use.

Model 431 same as 430 except has Readrite (GOOD-BAD) Meter

Dealer Price **\$15.90**

A MODIFIED EMISSION TYPE TESTER APPROVED CIRCUIT

READRITE METER WORKS, 120 College Ave., Bluffton, Ohio

Please send me more information on Model 430

Name

Address

City

State

TRIAD
RADIO TUBES
Insure
SATISFACTION

Used by Leading Set Manufacturers, and Preferred by Expert Servicemen

A Profitable Line to Handle

TRIAD
MANUFACTURING COMPANY
INCORPORATED
PAWTUCKET RHODE ISLAND

The Quality Name in Radio Tubes

chandising practices of the trade and thereby produce greater effectiveness of sales effort, more economical operation and resulting greater net profits.

It Will Take Money

In the consideration of any plan for a national organization the financial phase of the situation must be carefully considered and definite ways and means must be found for financing the promotional period which necessarily must precede formal organizing procedure.

It has already been stated that various now existing local or regional groups should be used as the frame work upon which to build the national organization. To get those local groups interested they must know *how* the national is to be set up, *who* is behind the movement, *how* it is to be run and *who* will probably be the managing group. After those points have been covered to their satisfaction someone will have to go and address those groups and do a selling job on their members.

A similar wholesale selling job will need doing in each important trading center which will mean that someone locally will have to organize or spon-

sor a meeting, lunch or dinner to get potential members out to hear the story.

Summarizing, the minimum of promotional activities, office expenses, salaries, postage, travelling expenses, the effort to organize **NATIONALLY** can have little chance of success unless somebody, somewhere underwrites the promotional operation to the tune of **NOT LESS THAN FIVE THOUSAND DOLLARS.**

Then to make sure that the proposed organization will be able to function with a fair degree of freedom it should not take out a charter and begin actual operation unless it has at least **TEN THOUSAND DOLLARS** in sight or uncancellably subscribed and another **TEN THOUSAND DOLLARS** coming in during its first year.

In other words such organization should have available \$20,000 annually. However, considering the fact that there are at least 20,000 retailers who would qualify immediately as potential members, it should not be difficult to support the effort out of a very nominal scale of dues. The pages of **RADIO RETAILING** are offered to a further discussion of this plan.

BEST RECORD PROSPECTS

(Continued from page 37)

profitable to concentrate on those who play as a form of recreation rather than as a means to a livelihood.

Investigate private schools and kindergartens. You can pick up considerable data here. Talk to the organists and choir leaders of your local churches. Get the names and addresses of the singers.

Ask your present radio customers if they like the recorded music programs aired, perhaps, by local stations. And, by the way, ask your local station about the response to such broadcasts. They'll talk advertising and we'll come to that later too.

Above all, never miss an opportunity of getting the names and addresses of everyone who evidences the slightest interest in good music. A live mailing list is indispensable to any record business. We hope the ideas sketched above will indicate the main sources from which you can expect the right names and addresses to keep yours humming.

AMPERITE
presents
THE ACOUSTIC COMPENSATOR

3 IMPORTANT USES

PUSH UP TO INCREASE HIGHS
PUSH DOWN TO INCREASE LOWS

(1) The Acoustic Compensator enables you to lower or raise the response of the microphone by the mere flip of the finger!
(2) Makes the Velocity immediately adjustable to close talking or distant pickup.
(3) Immediately adjustable to any type of job or occasion.

MODELS RBHk, RBMk, with acoustic compensator. Frequency range 40 to 11,000 CPS. Output, -65 db. Switch, cable connector, 25' of cable. **\$42.00 LIST**

MODELS RBHn, RBMn, without acoustic compensator **\$42.00 LIST**

MODELS RAH-RAL, excellent for speech and music. Reduces feedback. Output, -68 db. **\$22.00 LIST**

NEW! AMPERITE CONTACT MICROPHONE, for use on all string instruments. **\$22.00 LIST**
AMPERITE "HAND-I-MIKE," smallest velocity made; used as hand, desk, or stand mike. **\$22.00 LIST**

Write for new Illustrated Bulletins.
FREE: Window Decal & Window Display; also new sales helps.

AMPERITE Co. 561 BROADWAY, N. Y.

AMPERITE Velocity **MICROPHONE**

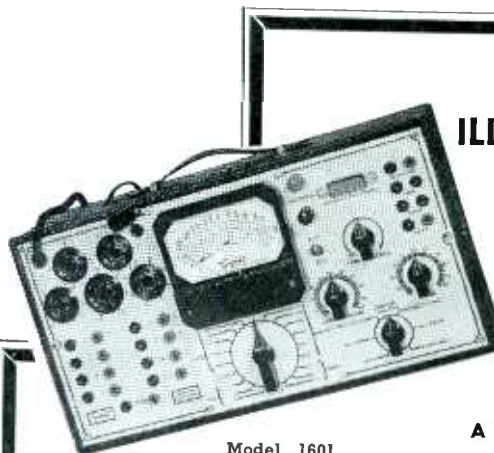

WITH MODERN FRONT ILLUMINATED INSTRUMENT



DELUXE SET TESTER
Has

ALL THE LATEST FEATURES FOR QUICK, ACCURATE SET TESTING

Model 1601
DEALER PRICE
\$45.33
In Metal Case

- ★ D.C. Volts at 25,000 Ohms per Volt. A.C. Volts at 1,000 Ohms per volt. Reads to 2,000 Volts A.C. and D.C. in 6 Ranges.
- ★ Resistance Measurements to 20 Megohms. Condenser Tester to 30 Mids.
- ★ 50 Microamperes to 20 Amperes in 9 Ranges.
- ★ New Single Zero Adjustment for Ohmmeter. All A.C. Operated. No Batteries Used.

A great advance in Set Testers is achieved by Triplet's new DeLuxe Model 1601 . . . has all the latest features, including many exclusive with Triplet . . . Plug-in type Copper Oxide Rectifier . . . 25,000 Ohms per volt . . . Large 4-inch square instrument with front illumination (a great aid for more accurate readings). Also available in attractive leatherette case with compartment with accessories . . . Dealer Price . . . **\$49.33**

ASK YOUR JOBBER
Write for Catalog

The Triplet Electrical Instrument Co.
201 Harmon Dr., Bluffton, Ohio 45017
Please send me more information on Model 1601; . . . I am also interested in . . .
Name
Address
City
State

INDEX TO ADVERTISERS

January, 1938

	Page		Page		Page
AMERICAN TELEVISION & RADIO CORP. (Vibrators)	76	HORTON MFG. CO. (Electric Washers)	62	RIDER, JOHN F. (Service Manuals)	73
AMPERITE CO. (Microphones)	81	HYGRADE-SYLVANIA CORP. (Tubes)	24	SERVEL, INC. (Refrigerators)	49
ARCTURUS RADIO TUBE CO. (Tubes)	74	INTERNATIONAL RADIO CORP. (Radio Sets)	17	SOLAR MANUFACTURING CO. (Condensers)	75
BRIGGS & STRATTON CORP. (Gas Engines & Generators)	10	JANETTE MANUFACTURING CO. (Rotary Converters)	64	STANDARD TRANSFORMER CO. (Transformers)	77
CHAMPION RADIO TUBE CO. (Radio Tubes)	78	JEFFERSON ELECTRIC CO. (Transformers)	73	STROMBERG CARLSON TELE. MFG. CO. (Radio Sets)	2
CLAROSTAT MFG. CO. (Volume Controls)	75	KELVINATOR DIV., NASH KELVINATOR (Refrigerators)	38, 39	TRIAD MANUFACTURING CO. (Tubes)	80
COLUMBIA BROADCASTING SYSTEM (Network)	42, 43	LEONARD DIV., NASH-KELVINATOR (Refrigerators)	46, 47	TRIPLETT ELECTRICAL INSTRUMENT CO. (Test Equipment)	81
CLOUGH-BREngle CO. (Test Instruments)	72	MALLORY & CO., INC., P. R. (Replacement Parts & Power Packs)	Inside Front Cover	TUNGSOL RADIO TUBES, INC. (Tubes)	77
COMMERCIAL CREDIT COMPANY (Finance)	6	MUeller ELECTRIC CO. (Wire Clips)	64	UNIVERSAL MICROPHONE CO. (Microphones)	76
CONTINENTAL RADIO & TELEVISION CO. (Radio Sets)	21	NORGE DIVISION, BORG-WARNER CORP. (Refrigerators)	57	UTAH RADIO PRODUCTS CO. (Vibrators)	75
CORNISH WIRE CO. (Antennas)	76	PENNWOOD CO. THE (Electric Clocks)	65	WARD PRODUCTS CO. (Auto Antennas)	60
CROSLY RADIO CORP. (Auto Radios)	Inside Back Cover	PHILCO RADIO & TELEVISION CORP. (Radio Sets & Tubes)	8	WARD LEONARD MFG. CO. (Replacement Parts)	73
CROWE NAMEPLATE & MFG. CO. (Remote Controls & Escutcheons)	63	PRESTO RECORDING CORP. (Recorders)	78	WESTON ELEC. INSTRUMENT CO. (Test Equipment)	70
EDISON GENERAL ELECTRIC APPLIANCE CO. (Refrigerators)	4, 5	RADIO CORP. OF AMERICA (Sound Engineering)	33		
GALVIN MFG. CO. (Auto Radios)	7	RADIO RETAILING (Trade-In Allowance Blue Book)	59	SEARCHLIGHT SECTION	
GENERAL ELECTRIC CO. (Radio Sets)	Back Cover	RAYTHEON PRODUCTION CORP. (Tubes)	3	<i>Classified Advertising</i>	
GENERAL INDUSTRIES CO. (Phono. Motors, Record Changers)	75	RCA MANUFACTURING CO. (Radio Sets, Tubes)	36, 51	Classification	Page
GIBSON ELECTRIC REFRIGERATOR CORP. (Refrigerators)	52	READRITE METER WORKS (Test Equipment)	80	BOOKKEEPING SERVICE	
HICKOK ELEC. INSTRUMENT CORP. (Test Instruments)	66	REMLER CO., LTD. (Inter-Communicating Systems)	62	Appliance Bookkeeping Service	83
				CATALOGS	83
				RADIO STOCKS	
				Burstein-Applebee Co.	83
				G & G Majestic Refrig. & Radio Parts Service	83
				Midwest Appliance Parts Co.	83
				Radolek Co.	83
				Standard Radio Co.	83

Although Radio Retailing takes every precaution to insure accuracy, we cannot assume responsibility for an occasional change or omission in the above index.

McGraw-Hill Publishing Company, Inc. Publication Office: 99-129 North Broadway, Albany, N. Y. Editorial and Executive Offices: 330 West 42d Street, New York, N. Y. Branch Offices: 520 North Michigan Avenue, Chicago; 883 Mission Street, San Francisco; Aldwych House, Aldwych, London, W. C. 2; Washington; Philadelphia; Cleveland; Detroit; St. Louis; Boston; Atlanta, Ga.

SEARCHLIGHT SECTION

EMPLOYMENT and BUSINESS OPPORTUNITIES—SURPLUS STOCKS—DISCONTINUED MODELS

UNDISPLAYED RATE:
15 cents a word, minimum charge \$3.00.
Positions Wanted (full or part-time salaried employment only) ½ the above rates, payable in advance.

(See ¶ on Box Numbers.)
Proposals, 50 cents a line an insertion.

(New advertisements must be received by January 22nd for the February issue)

INFORMATION:
Box Numbers in care of our New York, Chicago and San Francisco offices count 10 words additional in undisplayed ads. Replies forwarded without extra charge.
Discount of 10% if one payment is made in advance for four consecutive insertions of undisplayed ads (not including proposals).

DISPLAYED—RATE PER INCH:
1 inch \$8.00
2 to 3 inches..... 7.80 per inch
4 to 7 inches..... 7.60 per inch
An advertising inch is measured vertically on one column, 3 columns—30 inches—to a page. Contract Rates on request.
Radio Retailing

A FADING OPPORTUNITY

To Buy New Unbranded, Tested and Guaranteed R.C.A. Licensed Radio Tubes
AT THIS LOW PRICE

20c each
While They Last

TYPES			
1A6	6A7	46	82
2A3	6B7	49	83V
2A5	6E6	50	85
2A6	6F7	55	89
2A7	00A	56	257
2B7	10	57	864
5Z3	35	58	99V
6A4	41	59	99X
6A6	42	75	

Re-orders from satisfied users are rapidly depleting our stock—send your order NOW to avoid disappointment. **ACT AT ONCE!**

Orders under 50 tubes, you pay postage. Orders 50 tubes and over, we pay postage.
Order in quantities of 50 tubes and get 5 tubes (our selection) —FREE.
A total net worth in excess of \$10,000.00 assures the responsibility and reliability of this offer.
Orders \$10 and over, 20% with order balance C. O. D.

Special discounts allowed to quantity purchasers
No order less than (\$1.00) one dollar will be accepted

S. R. Co. 66 Lexington Ave., Passaic, N. J.

BOOKKEEPING SYSTEM

Designed especially for the small radio sales and repair store.
Larger systems for the general appliance dealer.

Don't guess at—profits, social security tax and loads of detail which this system will give you. Sales, repairs, customer's payments and expenses all entered on daily cash balancing sheet. Totals are transferred to properly designed records. Simple but complete.

Start the New Year Right!

Write today for particulars—stating your class of business

Reasonably priced. Complete instructions

APPLIANCE BOOKKEEPING SERVICE

111 W. Jackson Blvd. CHICAGO, ILL.

EMPLOYMENT

THE RIGHT MAN in the right place is a matter of vital importance to both the employer and the individual employee. The opportunity of benefiting from training, experience and ability suited to specific employment is equally great in its possibilities for both. Therefore choosing a prospective employee from among the most competent and experienced men that offer, or choosing the available employment best suited to the individual's qualifications, requires using the best means at the command of either, to assure satisfactory accomplishment. In the radio field Positions Vacant and Positions Wanted advertisements in these columns offer a means of contacting this industry and its personnel effectively and at small cost.

OPPORTUNITIES

BUYING, selling or investment opportunities naturally receive most interested consideration from individuals who are engaged in the industry with which such opportunities are associated. Such men know the requirements and possibilities of their industry. Business and personal interests and ambitions assure their being readers of this their business paper. An advertisement in these columns therefore provides the logical medium for inviting their consideration of business "opportunities" that are offered in the radio field.

YOU ARE ONE

of more than 20,000 readers of RADIO RETAILING.

Your problems of selling radio sets, accessories and other home merchandise—whether business or individual—are duplicated with other readers, but—

Still OTHER readers can provide the solution of your problem IF THEY KNOW WHAT IT IS!

Tell them! Here!

Through classified advertising in the Searchlight Section of RADIO RETAILING—your business paper and theirs.

RADIO IN IT'S ENTIRETY!

"B-A" serves the trade with every need in radio—complete 160-page catalog of nationally known radio receivers, public address, parts, supplies and equipment. Orders shipped same day received.

COMPLETE CATALOG AVAILABLE

BURSTEIN-APPLEBEE CO. 1012-14 MCGEE ST. KANSAS CITY, MO.

OVER 10,000 PARTS

FOR VACUUM CLEANERS AND WASHING MACHINES

24-HOUR SERVICE!

Attach this "Ad" to Your Inquiry and Receive Complete Catalog

Manufacturers Factory Representatives
MIDWEST APPLIANCE PARTS CO.
2722 W. Division St. CHICAGO, ILL.

\$500,000 GENUINE

MAJESTIC-GRIGSBY GRUNOW

REFRIGERATOR &

RADIO PARTS.

FOR MODELS

PRIOR TO

1938

Majestic

UNITS

GUARAN-

TEED 18 MONTHS.

SEND FOR PRICE LIST.

G & G GENUINE MAJESTIC RE-

FRIGERATOR & RADIO PARTS SERVICE

5801 W. DICKENS AVE. CHICAGO, ILL.

STOP SEARCHING!

HERE IS YOUR "GUIDE"

LOWEST PRICES

SEND FOR YOUR COPY NOW!

GUARANTEED QUALITY

FASTEST SERVICE

The new 1938 Radolek Radio Profit Guide contains complete showings of Radio Repair Parts, Radio Receivers, Public Address Amplifiers, Speakers, Microphones, Service Test Instruments, Radio Technical Books, Special Radio Tools. Leading Standard Brands! Everything you will ever need in the Radio Business all at Lowest Prices. You save money at Radolek!

Every item you get from Radolek is guaranteed. It must be right or we make it right. Standard merchandise produced by leading Manufacturers with Radolek's guarantee added!

Everything in Radio promptly when you want it—and exactly what you want. Radolek's efficient organization backed by a huge stock of standard guaranteed quality merchandise insures you the fastest service in the Radio business. Twenty-five Thousand Servicemen customers depend on Radolek service and benefit by Radolek's LOWEST PRICES. Send Now for your copy of the Radolek Radio Profit Guide. It will help you make money.

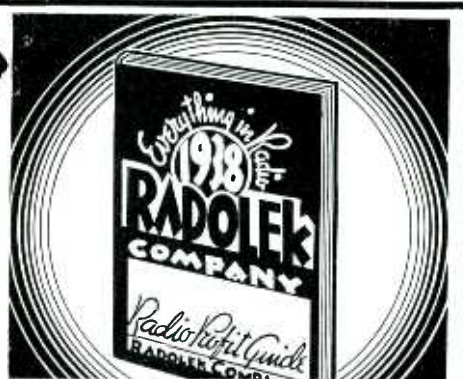

RADOLEK

601 W. Randolph St., Dept. A-15, CHICAGO

Name

Address

Serviceman? Dealer? Experimenter?

Rely on Radolek for "Everything in Radio"

Audio Frequency...

You Exaggerate, Mister

Conditions for we radio retailers in Washington are such that we believe, after seventeen years' experience, radios can only be sold at a loss.

The basic reason for these conditions are: (1) Distributor dumping, (2) Unfair chain competition, chains frequently retailing sets at such prices that we cannot even purchase as well through our local distributors. (The growth of these chains has been due to highly transient character of our population, (3) Public being educated to the extent that they can purchase any new, 1938 standard make radio for 40 per cent off, (4) The public is buying practically any new 1938 radio for 40 per cent, 45 per cent or 50 per cent off (5) False advertising, (6) Direct from factory purchasing and, (7) Washington has become a dumping-ground for manufacturers' surpluses, gyp sets and price merchandise.

Radio Retailing could be a definite help now, not only to we radio dealers of Washington but to dealers all over the United States, who through lack of organization, have been unable to curb the activities of those few organizations who stress price above service at the expense of the public. WASHINGTON, D.C. JOS. C. KENNEDY

Perhaps the story entitled: "Do We Need a National Association of Radio & Appliance Retailers," in this issue, will interest you.

About Dummy Tubes

The number of tubes used in a radio receiver has, up to now, been the measure of value or, at least, the public has been taught to think so. The question is not if it is rightly so, although it might be well to correct if receivers of leading manufacturers are considered, but the wrong use being made of this impression of the public and even of the trade.

For some time now, there have been on the market a number of receivers with an abnormal number of tubes for their size and price range manufactured, some of them, by fairly large and well-known concerns, which sets, however, do not give the average performance expected of a bona fide receiver of the same number of tubes, making it clear that tubes are just added as dummies and do not add to the performance of the set, which fact might well fall under the terms of "unfair competition."

It seems to me that if the RMA would fix a certain amount of work for each tube in terms of performance, or gain per stage, or special function; that if cooperation of patent owners could be secured in the form that they fix royalties per tube, instead of on value; that, if possible, the excise tax would apply on number of

tubes instead of selling price, the above problem would be solved.

LAREDO, TEXAS

J. M. VELASCO

The RMA has been working on just such a means of fixing the function of tubes, is nearly ready to submit its recommendations at Washington for inclusion in proposed Fair Trade Practice rules.

"Kitchen Mechanics"

I have a suggestion which might help many servicemen who maintain shops, and so have difficulty competing with "kitchen

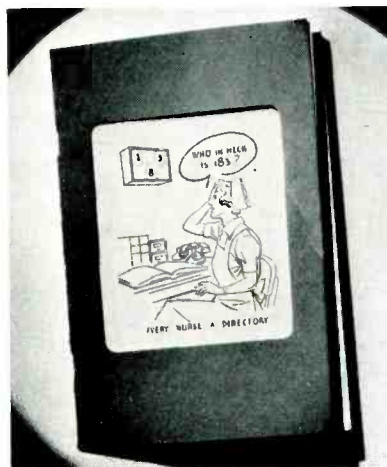

A DOCTOR TALKS SOUND—Interesting little booklet found in our mail was written by John E. Gorrell, B.Sc., M.D., director of the Blodgett Memorial Hospital of Grand Rapids. In it, the Doc tells what in his opinion hospitals really need in the way of inter-communicating devices. Good, inside dope for sound equipment makers, distributors, dealers who can wheedle a copy out of him

mechanics," to combat this type of competition.

How about a throw-around card with two drawings. On one side show the "kitchen mechanic" trying to repair a set on the kitchen table while his wife jostles his elbow, ironing, and a youngster generally gets under foot. Then, on the other side, show the really efficient setup used by a man working from a shop, with every necessary instrument neatly arranged to hand?

Might even be a good idea for a "twin" window display.

MINEOLA, N. Y.

H. E. BEATTY
Mineola Radio Shop

Tough

In the Pittsburgh *Post-Gazette* of December 17 the used-car department of one

of the largest automobile salesrooms advertises that it will give away free a brand-new, 1938 console radio with each used car offered in the ad. The radio offered is a standard make. We are stocked up on it.

This is merchandising used automobiles at the expense of legitimate radio dealers. In our fifteen years in the radio business we have never before seen such a chaotic condition. Even Cortlandt Street in New York and South State Street in Chicago would bow their heads in shame at some of the wild deals that are pulled here.

MERCER, PA.

MCCALLA BROTHERS

This is a penalty radio pays because it is so extremely attractive to the consumer. There's nothing you can do about premium deals, where the man who offers them really lives up to his promises . . . except get mad at the set distributor and manufacturer. And sometimes they can't control merchandise when it leaves their hands, wanting to, because there is no legal way to do it.

Little Green Discount Cards

A letter has just been mailed to most of the large plants and businesses here, by a dealer, inclosing a "wholesale discount card" and offering up to 40 per cent discounts on radio and appliances purchased by employees.

How can this type of racket be stopped? DETROIT MILTON L. KEVRISON
Uptown Radio Company

It's a tough kind of competition. You'll be interested in the article in this issue entitled: "5 Letters About Industrial Discounts." You've got to be organized to do anything, though.

Likes "Tricks"

After receiving my copy of "Tricks of the Trade" from *Radio Retailing* I saw on the inside covers some very truthful illustrations.

I am referring to the page entitled: "Why Good Service Can't Be Cheap" and others of this character. "How Much Electricity" and "Why Good Servicemen Charge For Inspection" were particularly good.

I would like to get some enlarged copies of all three of these. I think a lot of your magazine.

MARSHALLTOWN, IOWA ROY O. JACKSON

Permit me at this time to express my thanks and appreciation for your splendid magazine, *Radio Retailing*, and the price-less benefits I have derived from same.

Also, please publish more dope regarding oscilloscope servicing.

MANSFIELD, OHIO FRANCIS M. SCHOENIAN
Buck's Radio Service

We're working on an oscilloscope series right now, hope to begin publishing it in February, or March at the latest.

A YEAR 'ROUND SALES LEADER.

CROSLEY FIVER ROAMIO

THE WORLD'S FASTEST SELLING AUTOMOBILE RADIO!

\$1999

The year's "best seller" in the automobile radio field . . . a sure fire, year 'round business getter for every radio dealer—the sensational Crosley Fiver Roamio! Stock this remarkable receiver and make your radio "sales and profits curve" shoot up.

CROSLEY FIVER ROAMIO—5-tube superheterodyne . . . Octal base tubes . . . Full automatic volume control . . . strong clear volume . . . Large, easily-read, illuminated Mirro-Dial . . . One piece installation . . . Low battery drain.

(Prices slightly higher in South and West.)

THE CROSLEY RADIO CORPORATION, CINCINNATI • POWEL CROSLEY, Jr., Pres.

Home of "the Nation's Station"—WLW—500,000 watts—70 on your dial

YOU'RE THERE WITH A CROSLEY

1938  Happy New Year 1938

OFF TO A
FLYING START
THE NEW 1938
GENERAL
ELECTRIC



TOUCH TUNING RADIO

TOPPING THEM ALL IN THE POPULAR PRICE CLASS

The Sensational Model F-96

SELL THE LINE
THAT LEADS IN
AUTOMATIC TUNING
G-E TOUCH TUNING

- ★ 9 TUBES
- ★ TOUCH TUNING Press a button—that's all!
- ★ AUTOMATIC FREQUENCY CONTROL
- ★ SILENT TUNING
- ★ LOUVER DIAL
- ★ TONE MONITOR
- ★ TWO STAGES OF INTERMEDIATE FREQUENCY
- ★ AUTOMATIC BAND INDICATOR
- ★ AUTOMATIC TONE COMPENSATION
- ★ PRE-SELECTOR R.F. STAGE
- ★ 12-inch STABILIZED DYNAMIC SPEAKER
- ★ VISUAL VOLUME AND TONE CONTROL
- ★ CUSTOM-CRAFT FULL-SIZE CABINET

*The
New
1938*



GENERAL ELECTRIC
RADIO



Appliance and Merchandise Department, General Electric Company, Bridgeport, Connecticut